

Cuaderno de Actividades
para el Verano
Educación Infantil 3 años



FORMAS GEOMÉTRICAS



Técnica: Pintar y picar



CRA Los Llanos

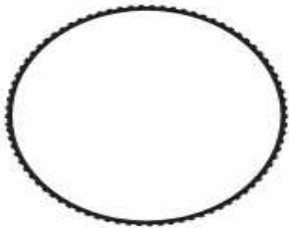
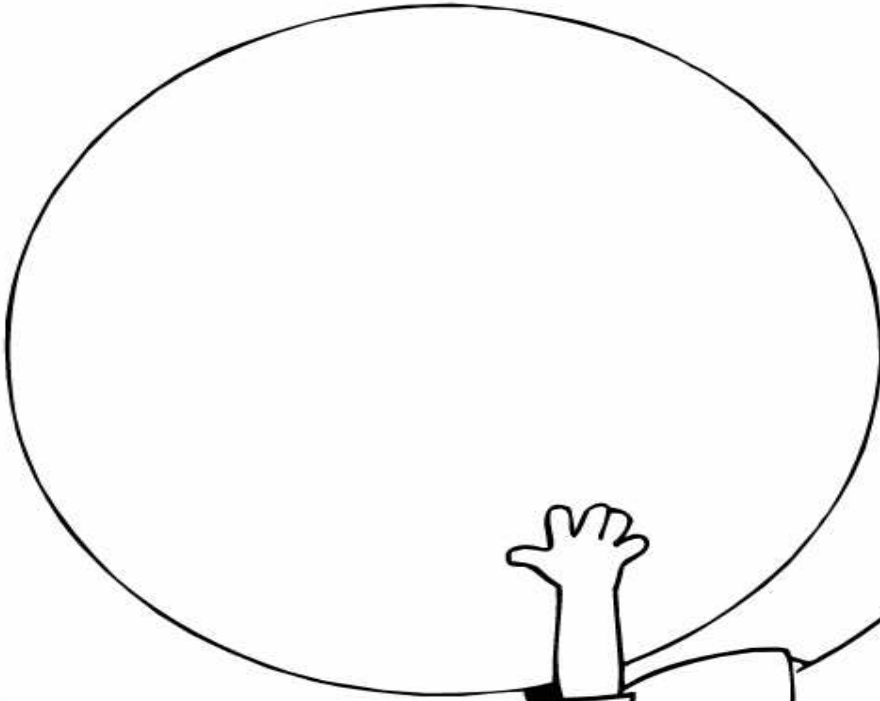
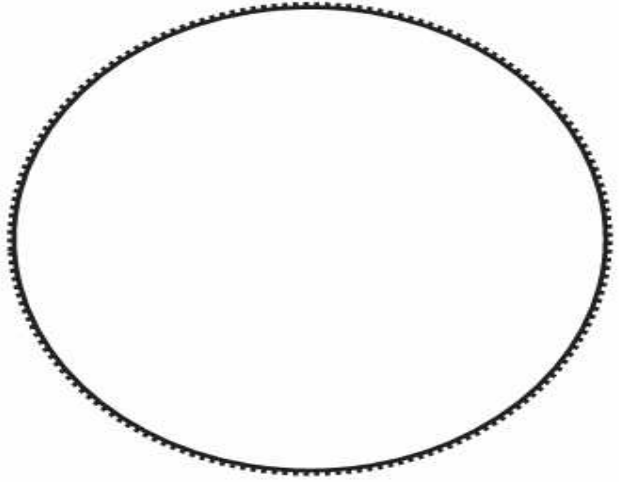
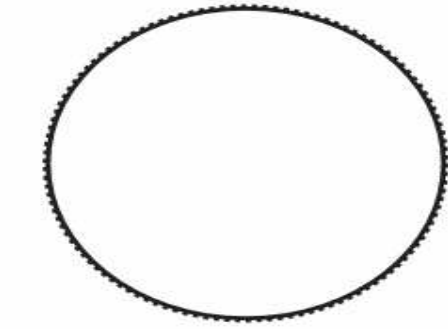



NOMBRE:

A dashed rectangular box for writing the name.

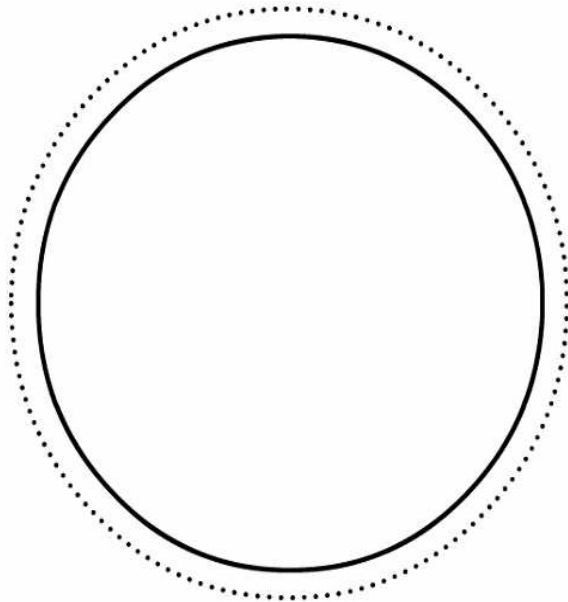

CÍRCULO

Círculo



Colorea la figura y pica por la línea de puntos.



NOMBRE:

Dashed rectangular box for writing the name.

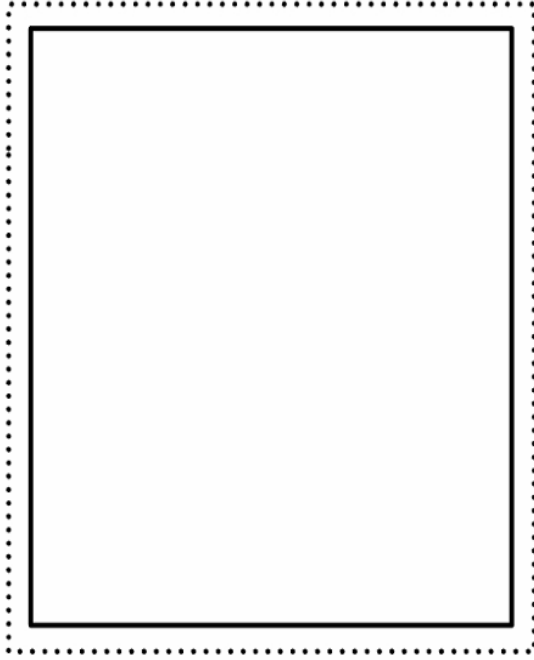

Cuadrado

CUADRADO



Colorea la figura y pica por la línea de puntos.



NOMBRE:

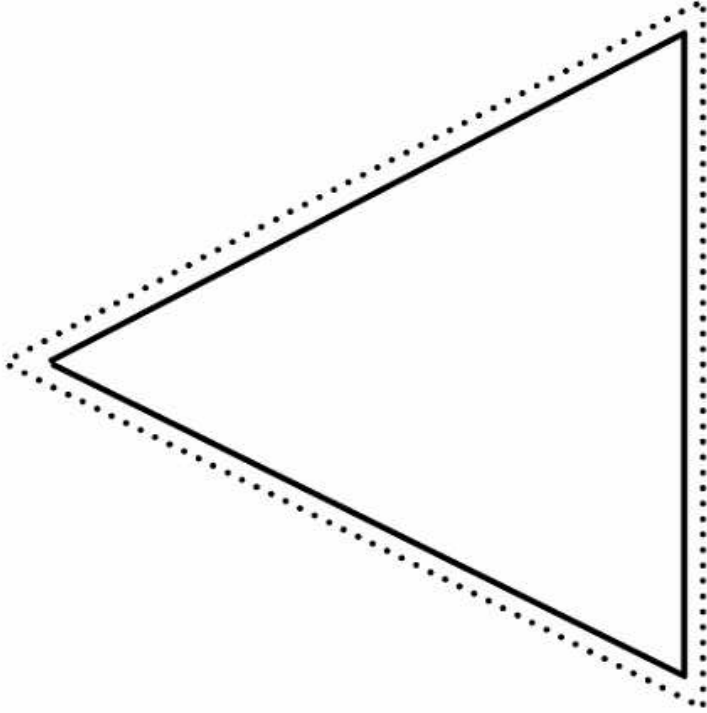

TRIÁNGULO *Triángulo*



Colorea la figura y pica por la línea de puntos.



Tarea: Reconocemos los círculos.
Técnica: Colorear con ceras duras.



CRA Los Llanos

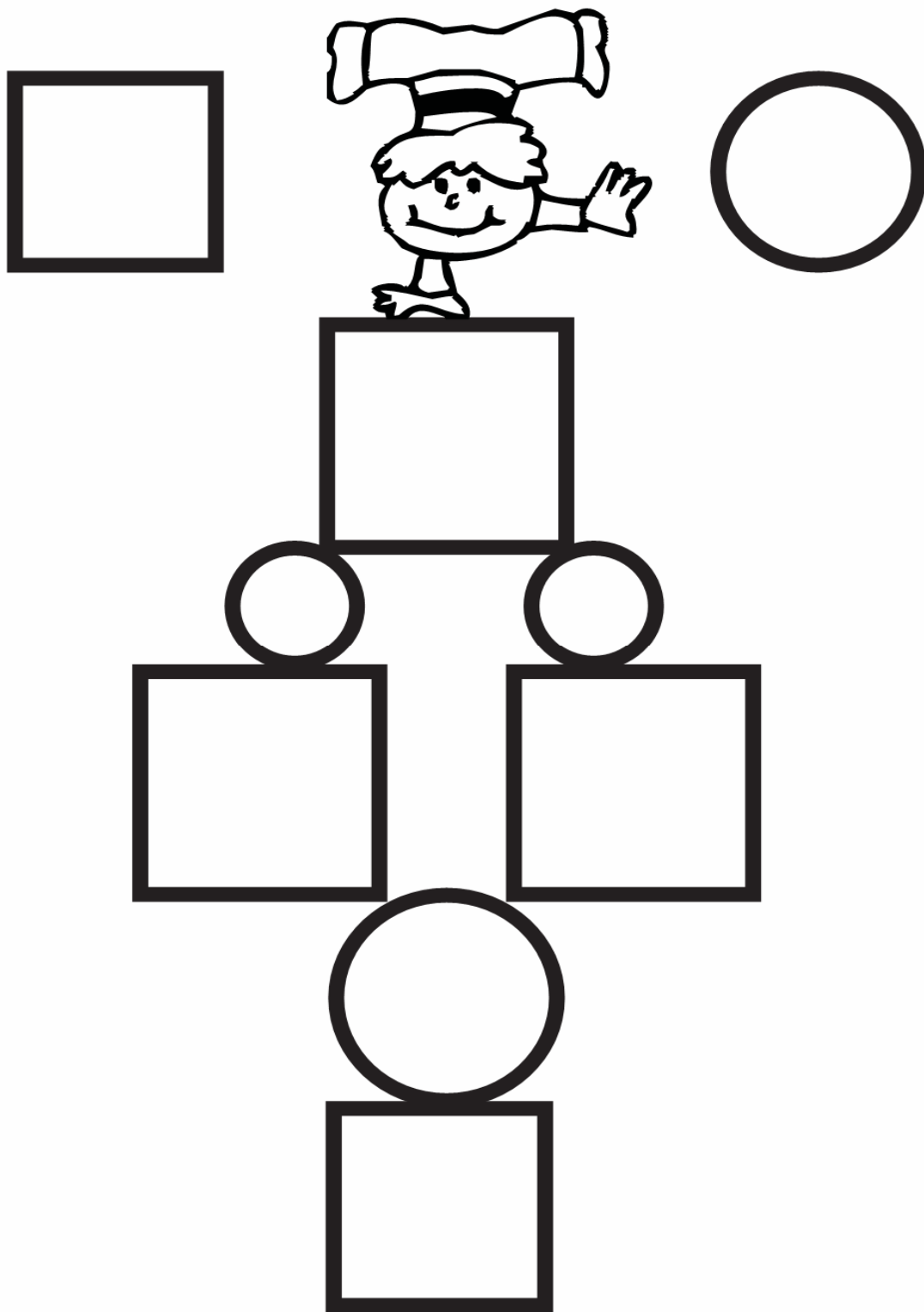

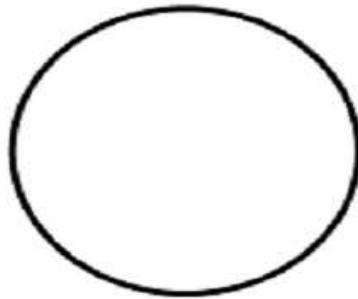
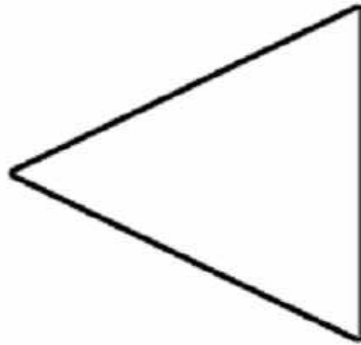
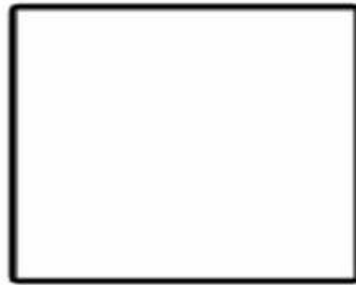
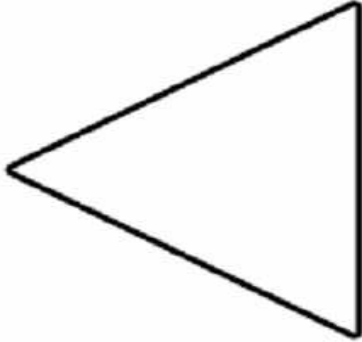
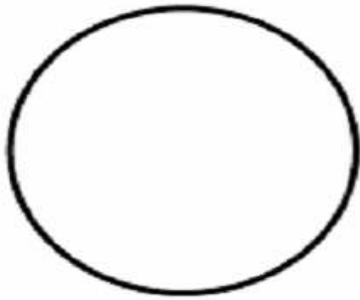
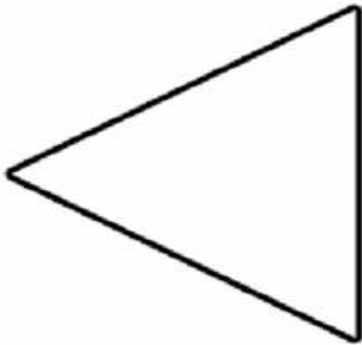
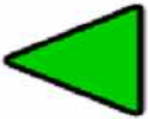
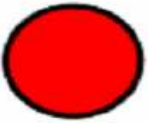
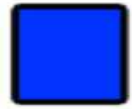

Nombre :

Curso :

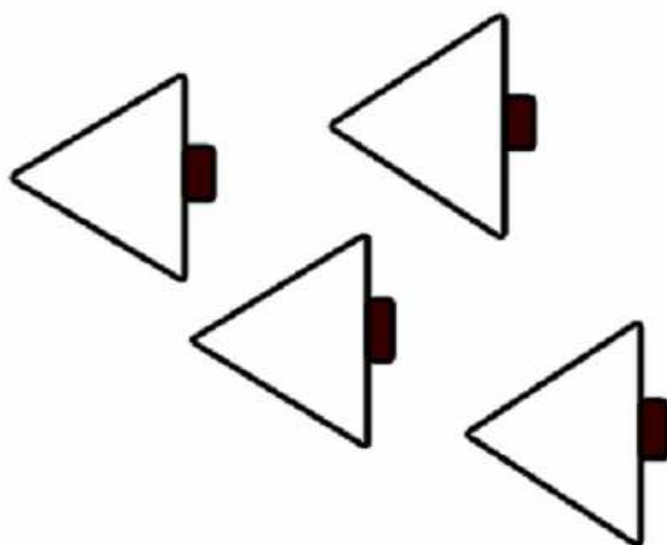
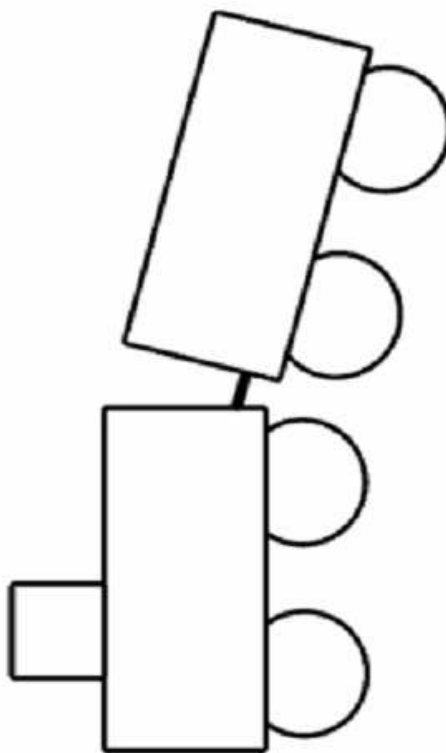
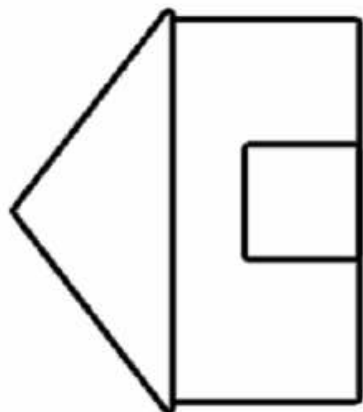
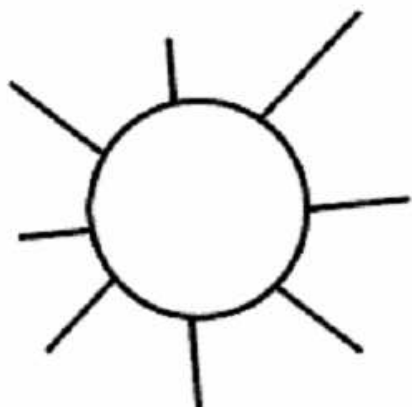
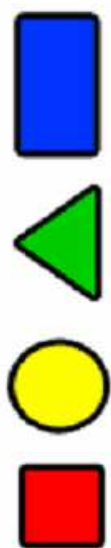

Curso :

Nombre :

LOS NÚMEROS

1, 2 y 3

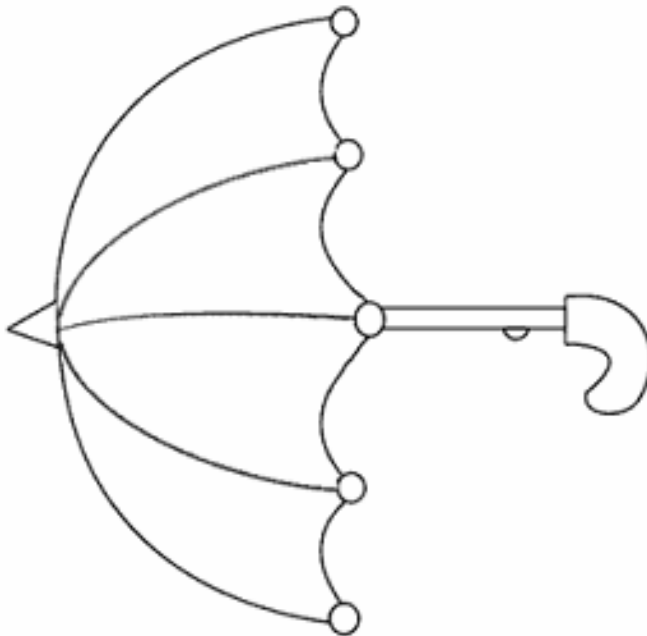
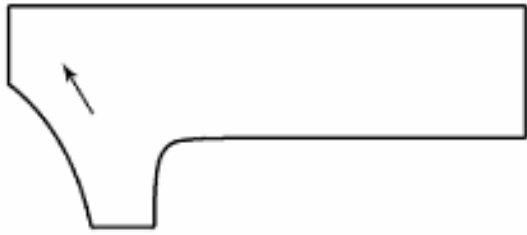

Curso :

Nombre :

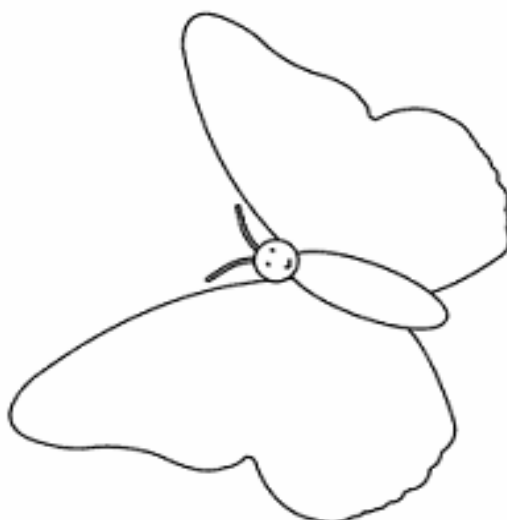
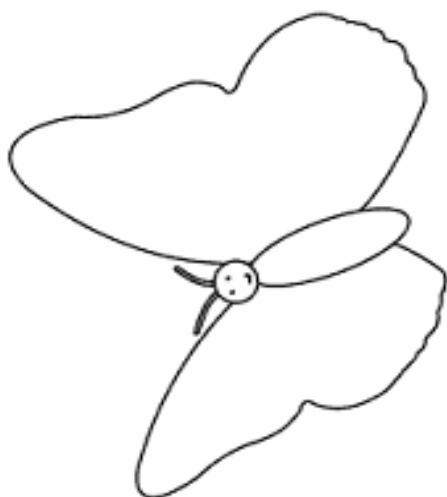
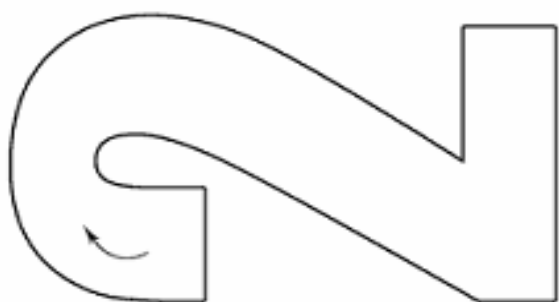

Curso :

Nombre :

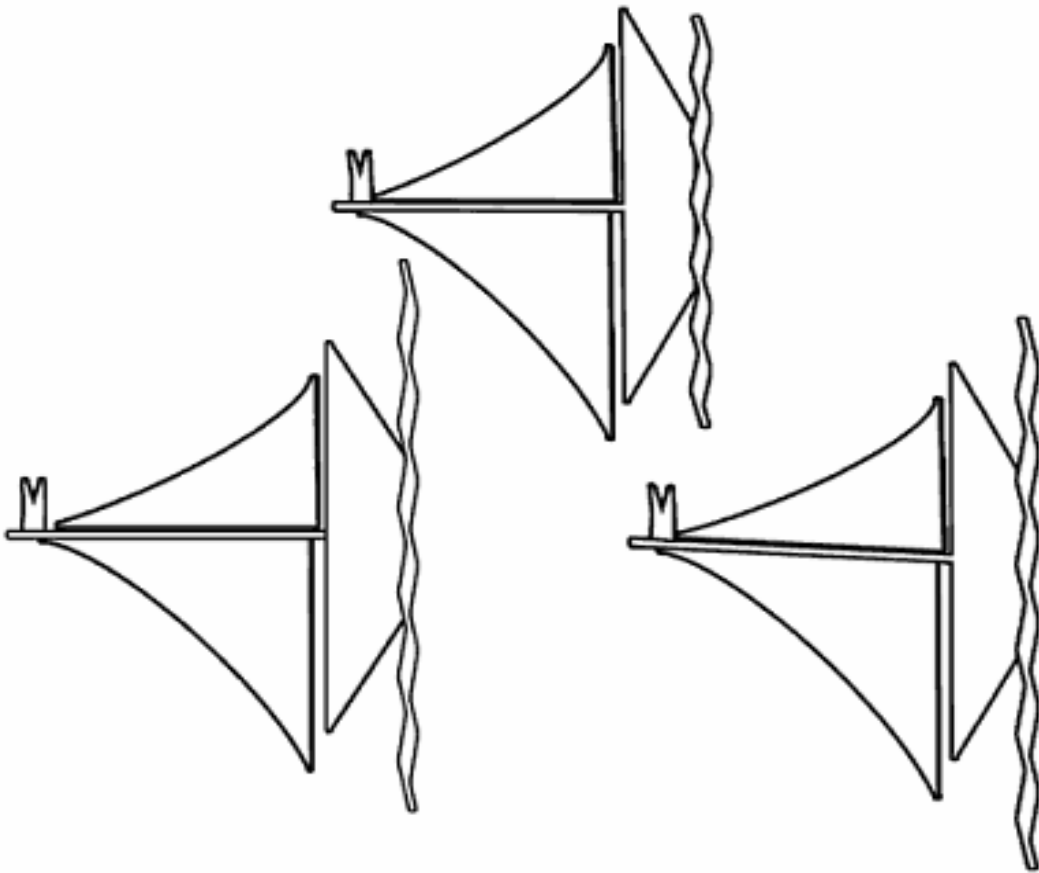
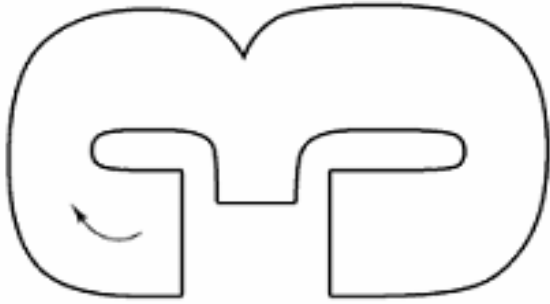

Curso :

Nombre :

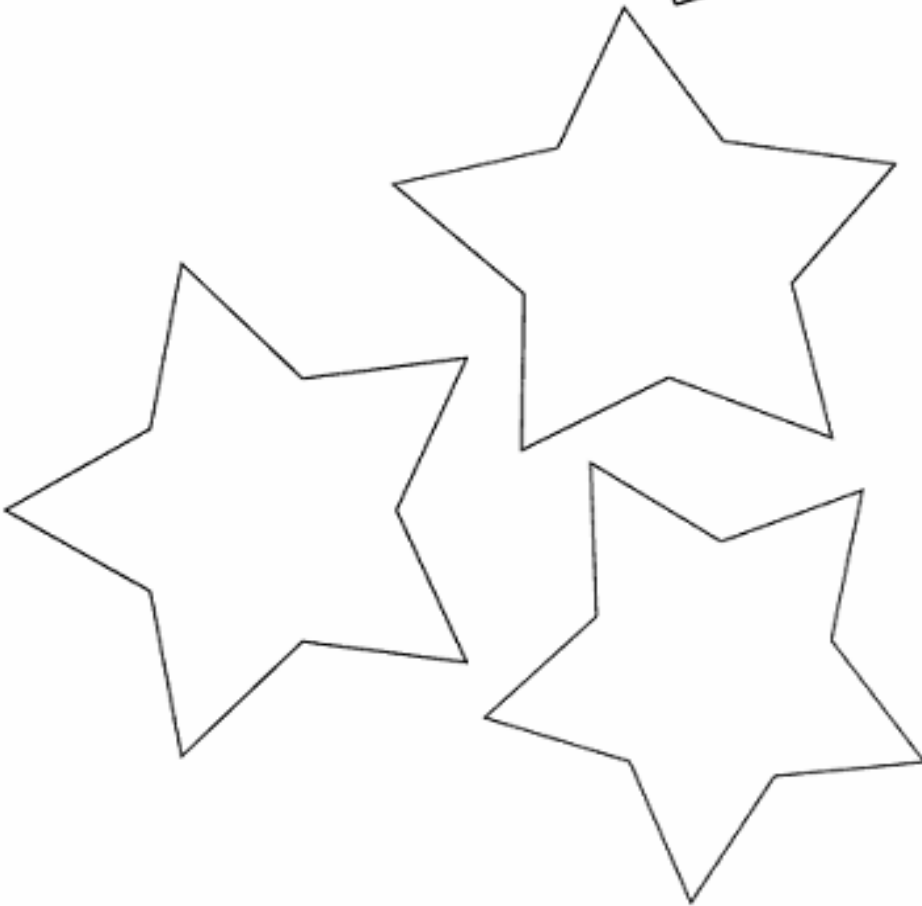
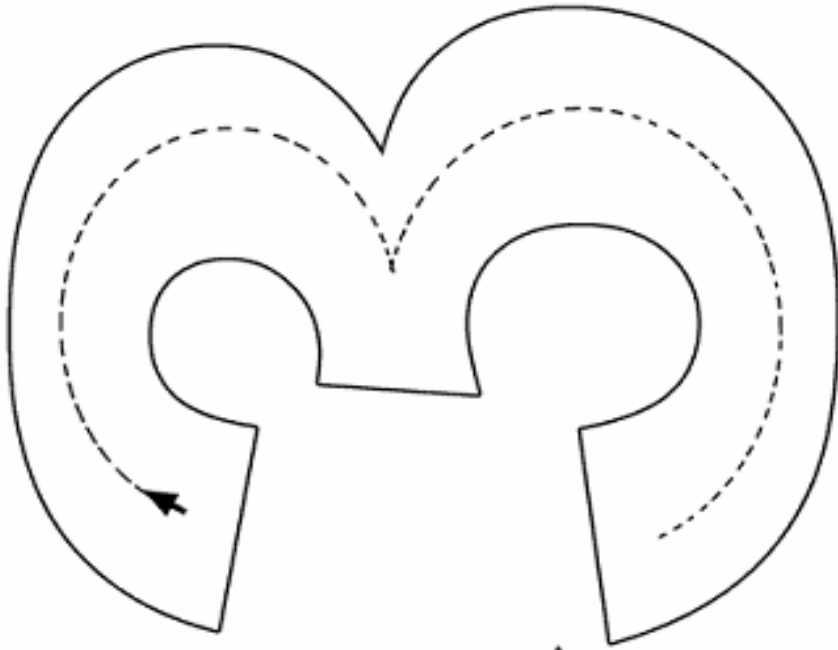

Curso :

Nombre :

Une y Colorea los Dibujos

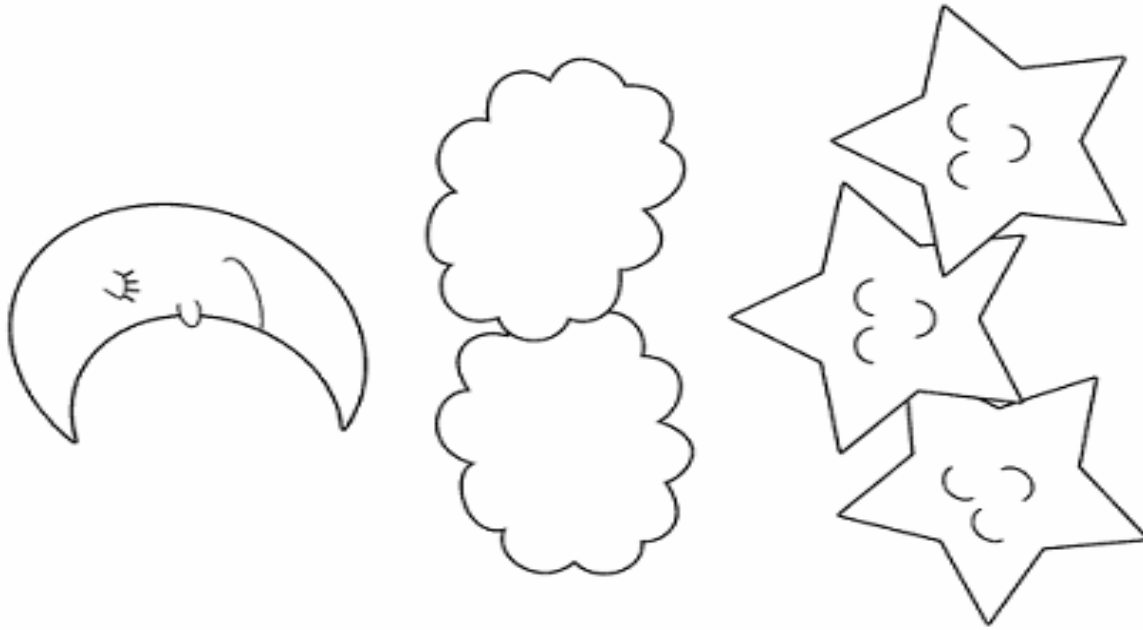

Nombre :

Curso :



Nombre :

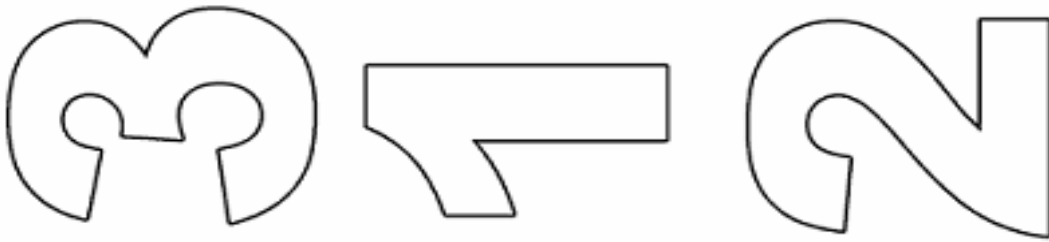

Curso :

GRAFO- MOTRICIDAD Y VOCALES

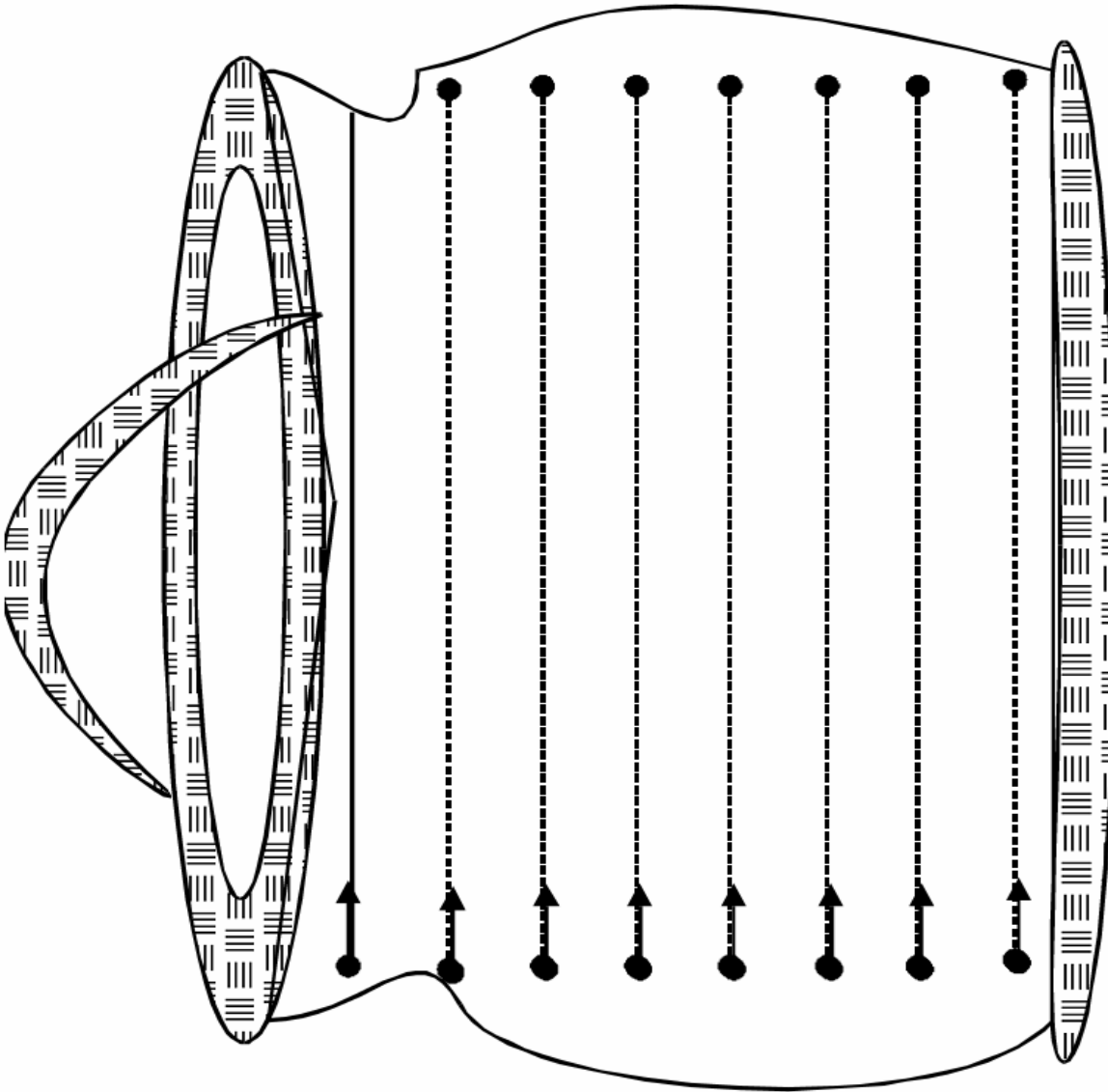

Repasa y después pica por el camino.

Repasa y después pica por el camino.

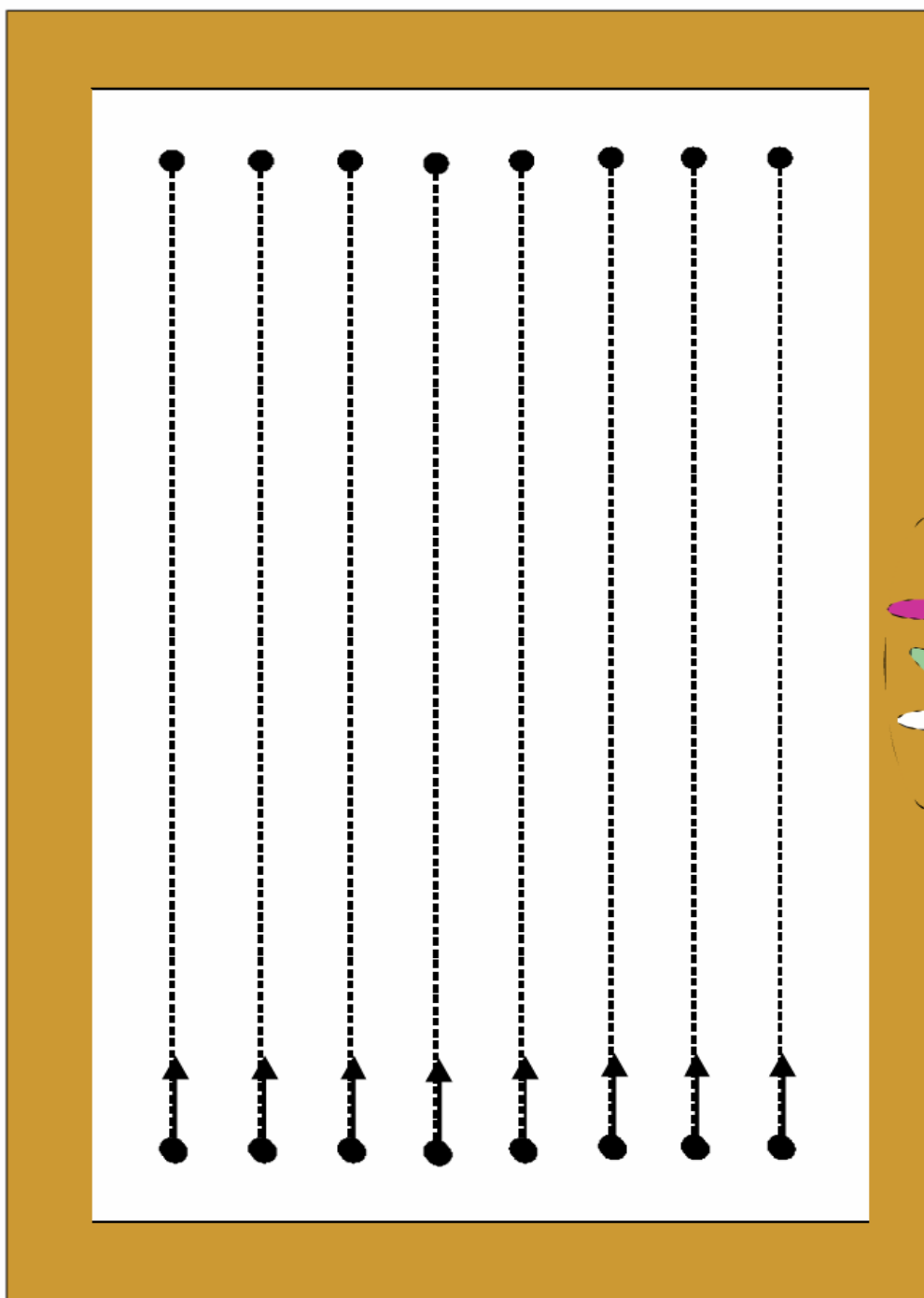

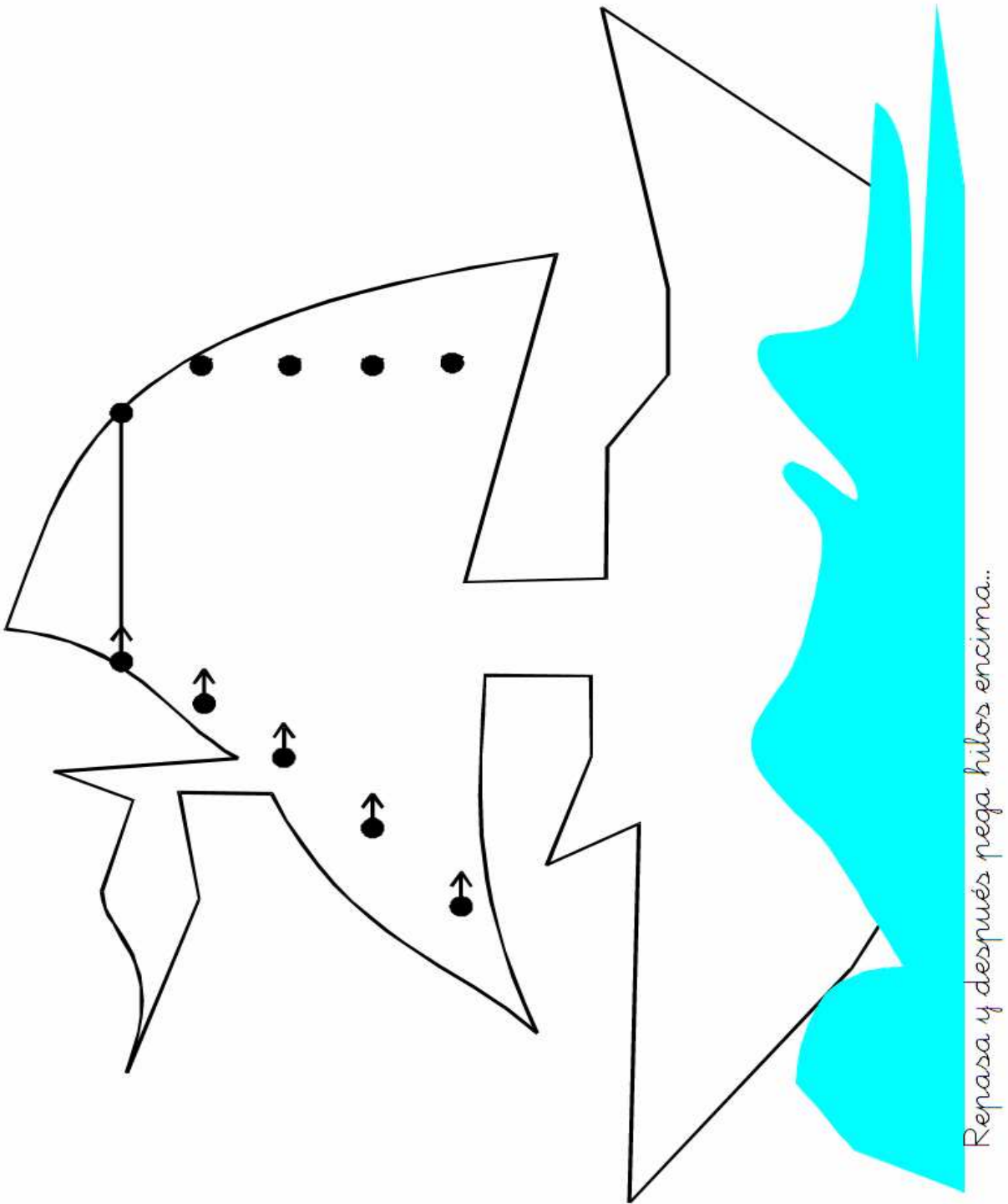

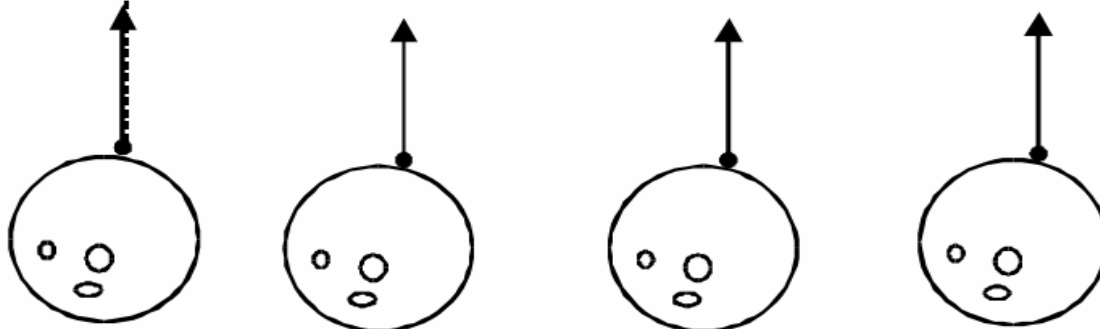
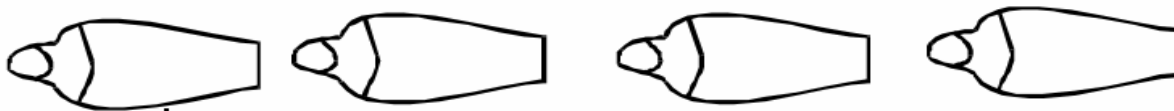

Repasa y pega bolitas de papel por el camino.

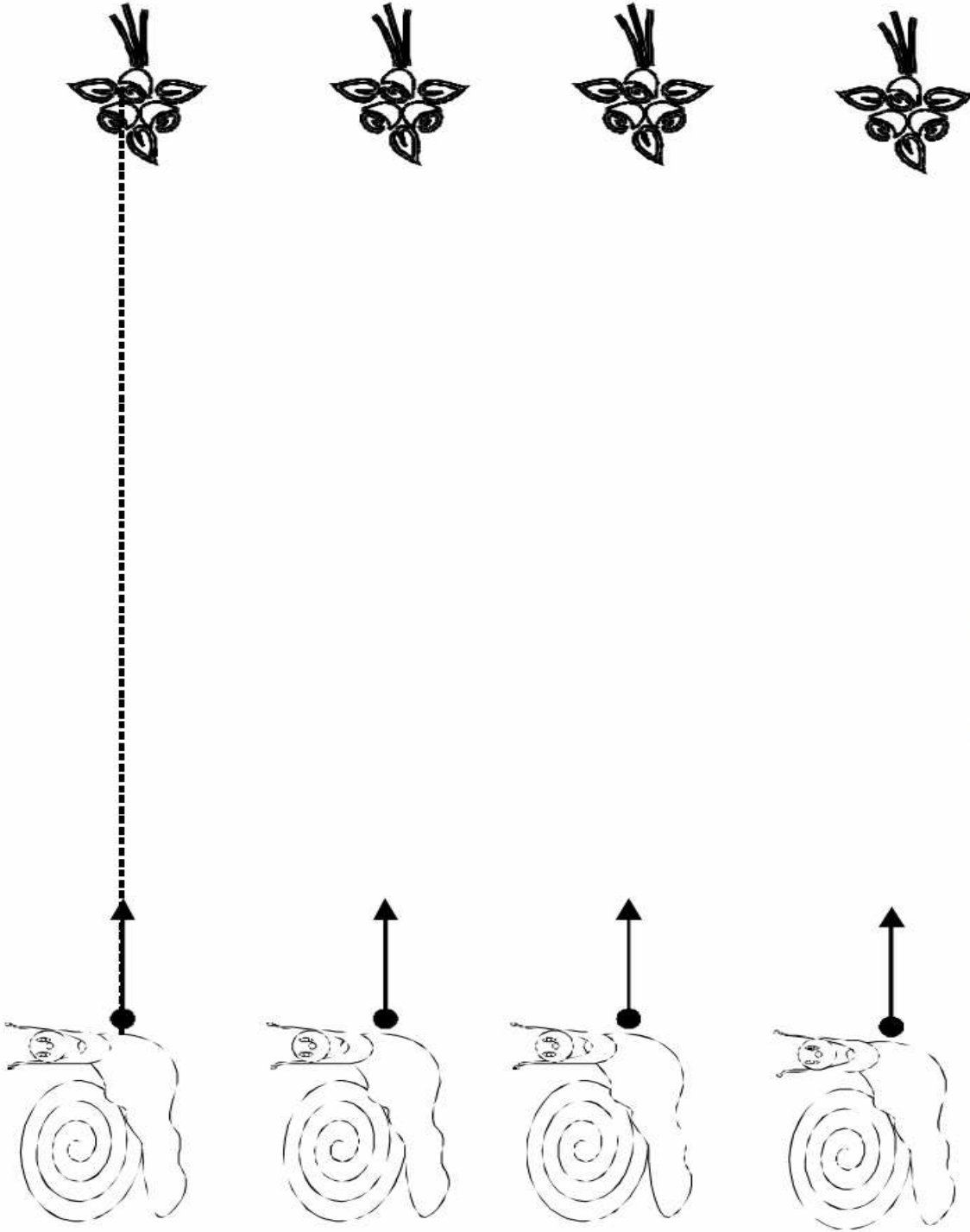

Repasa y pega trocitos de hoja por el camino.

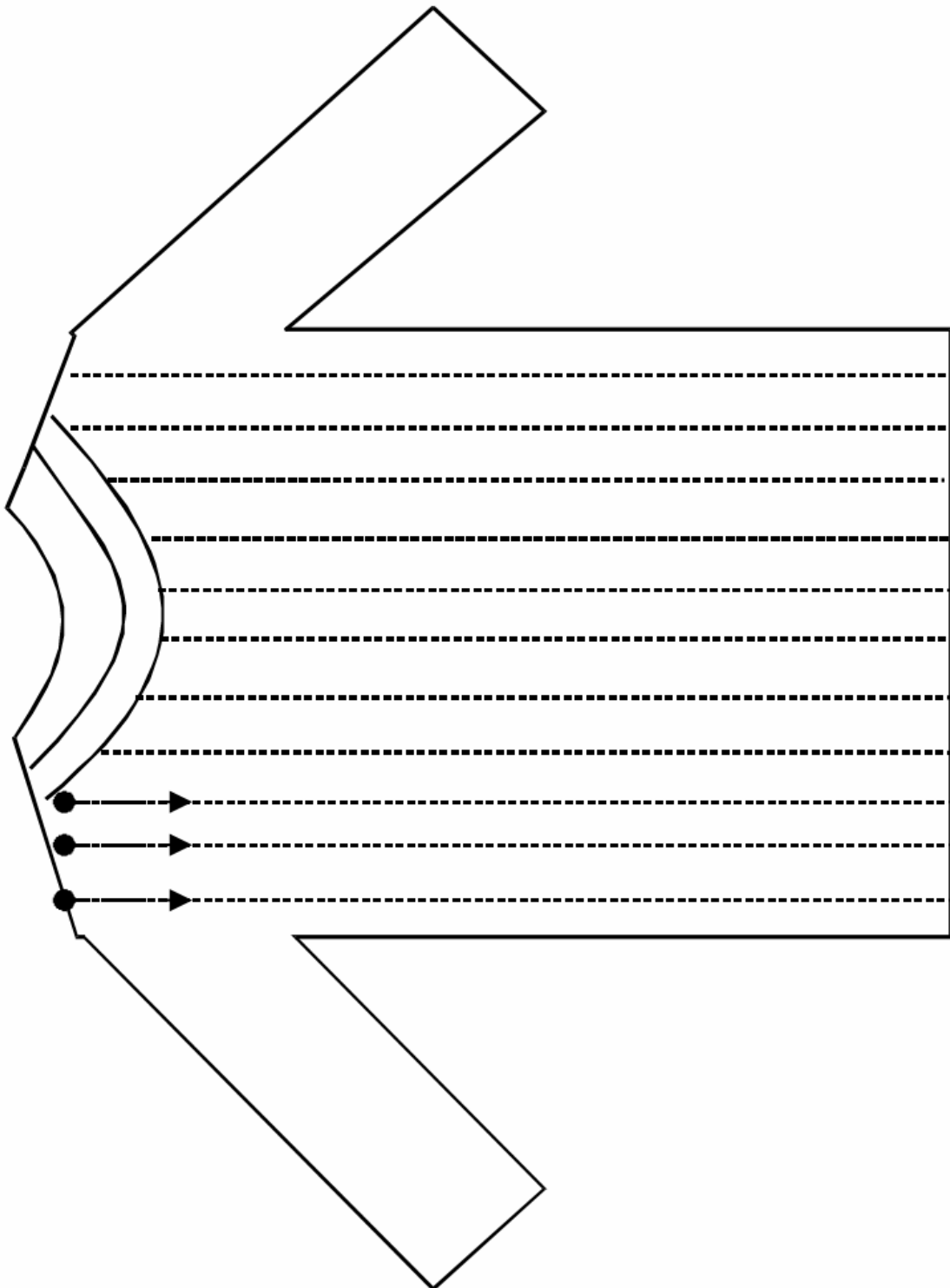

Repasa con colores y después pica sobre las líneas.

Haz las púas del peine y pega palillos encima.

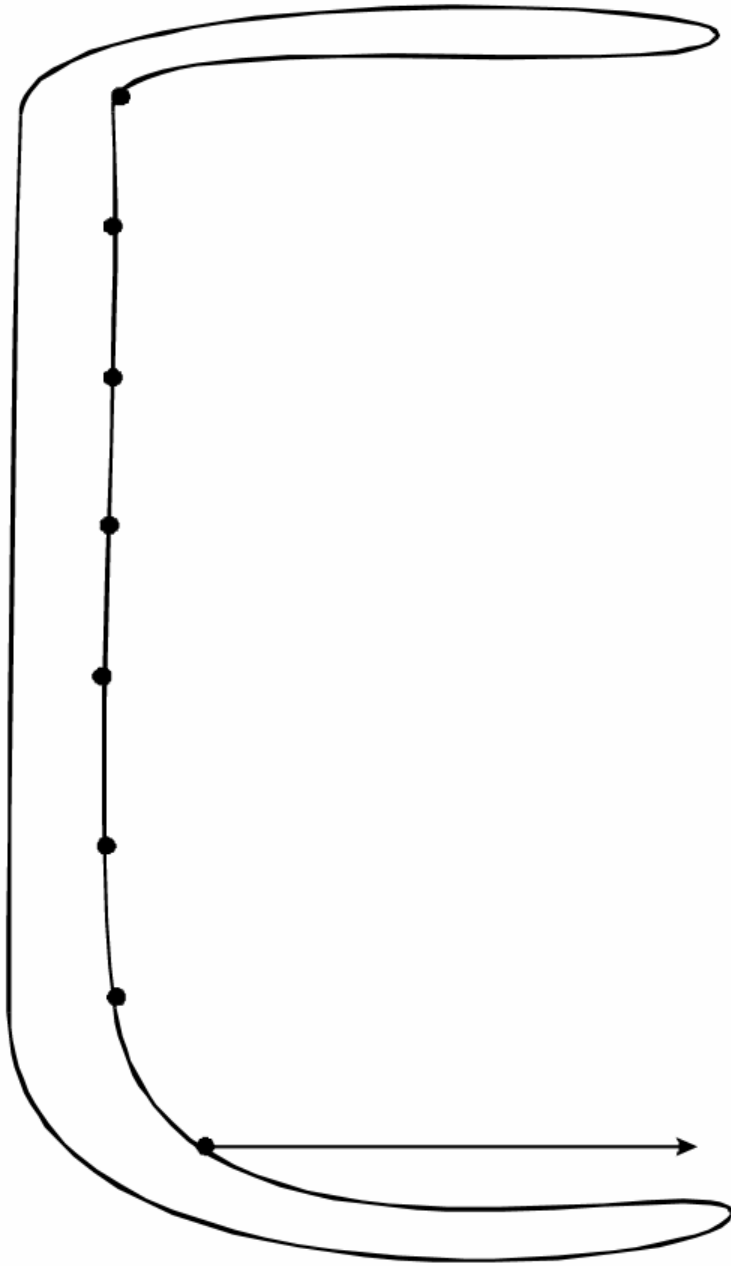

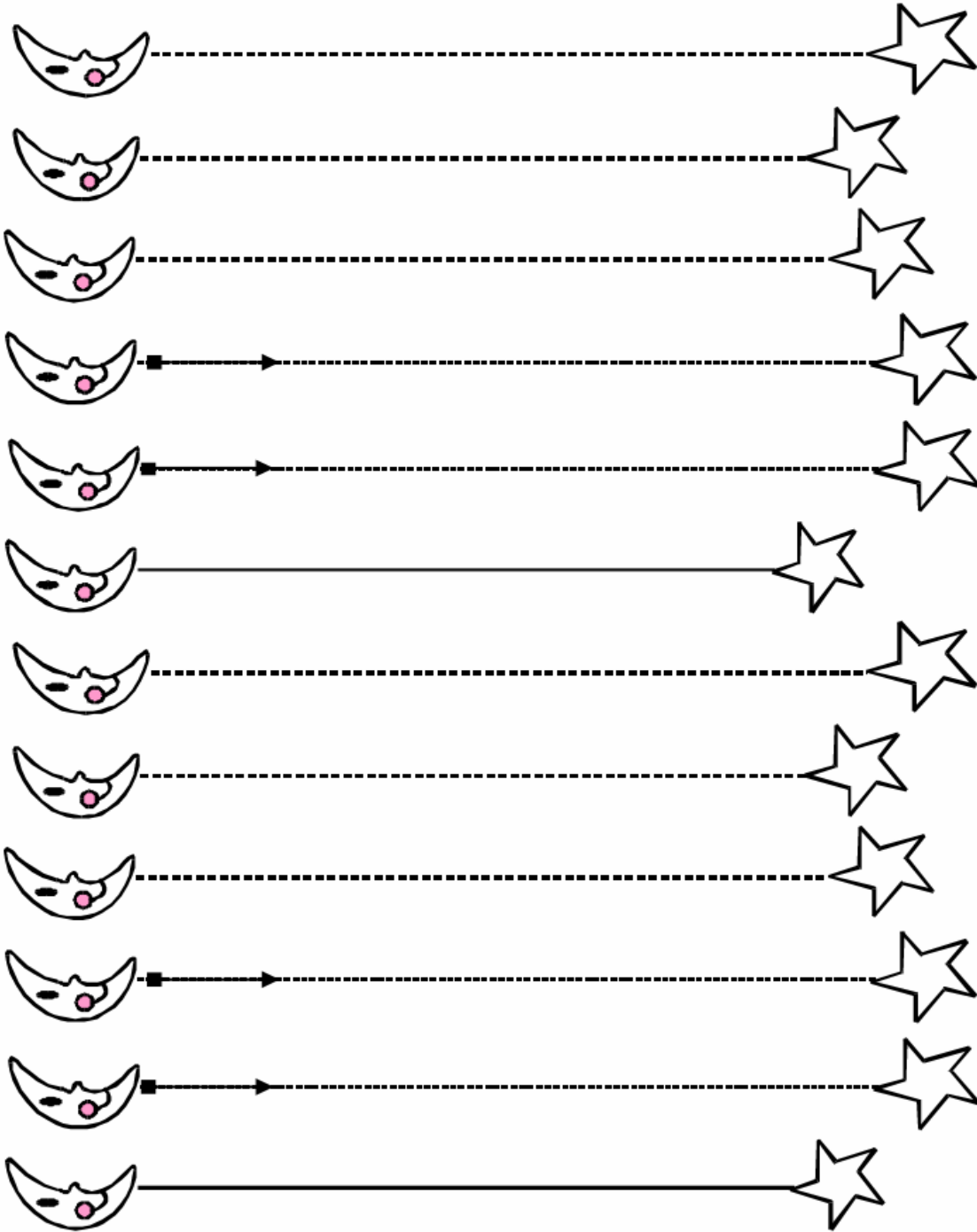

Repasa las líneas y pega lana de colores encima.

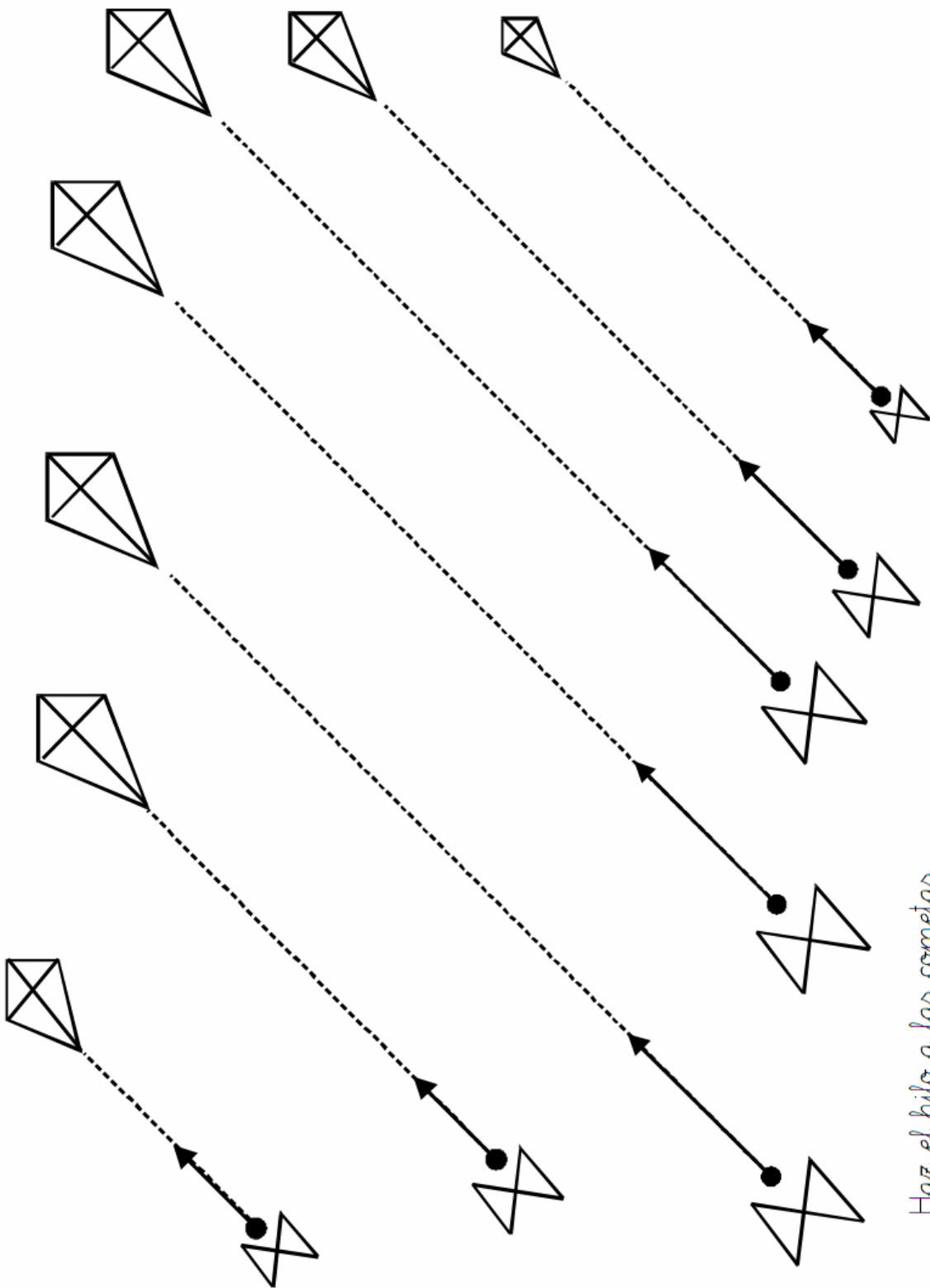

Haz el hilo a las cometas.

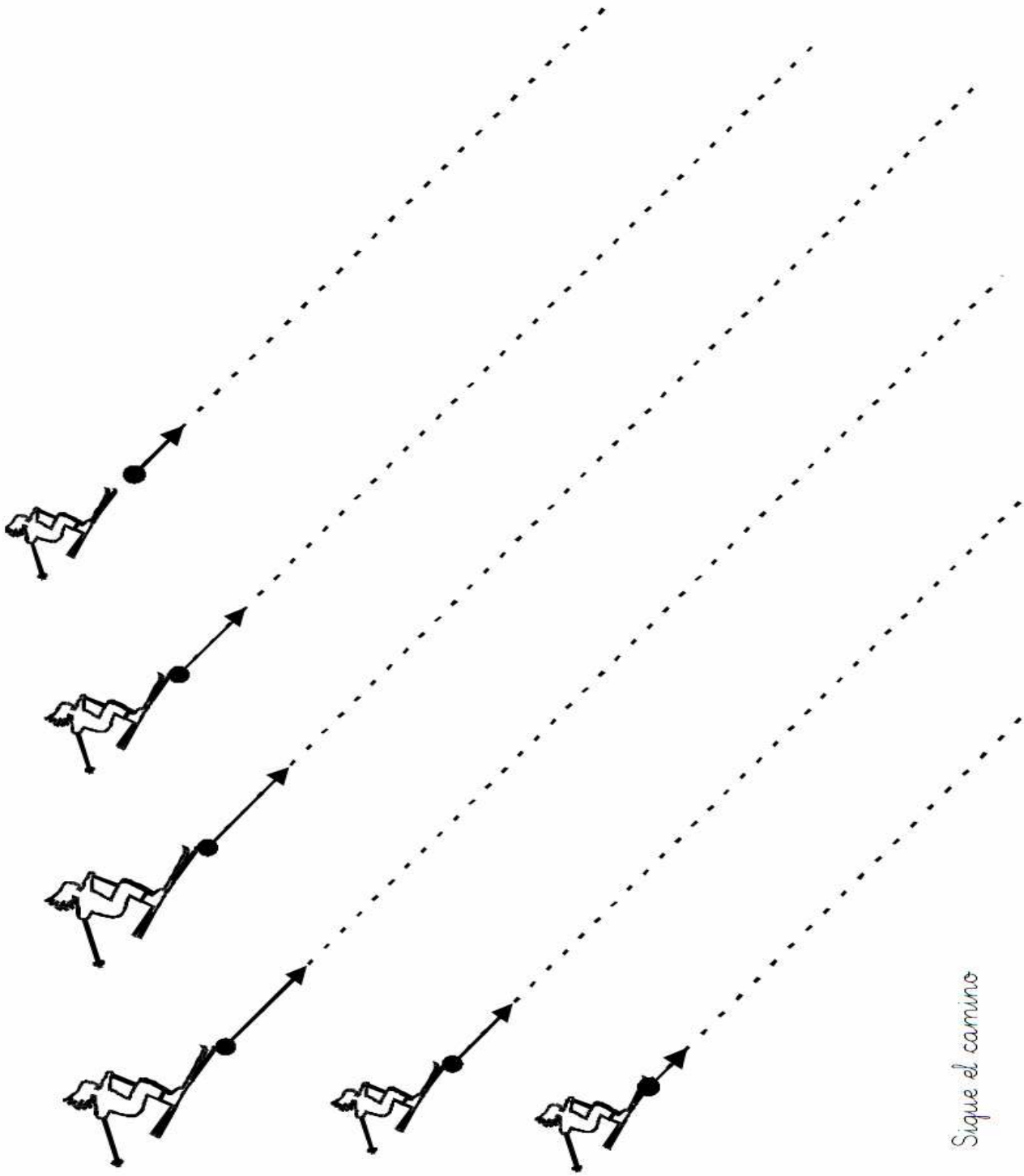

Sigue el camino

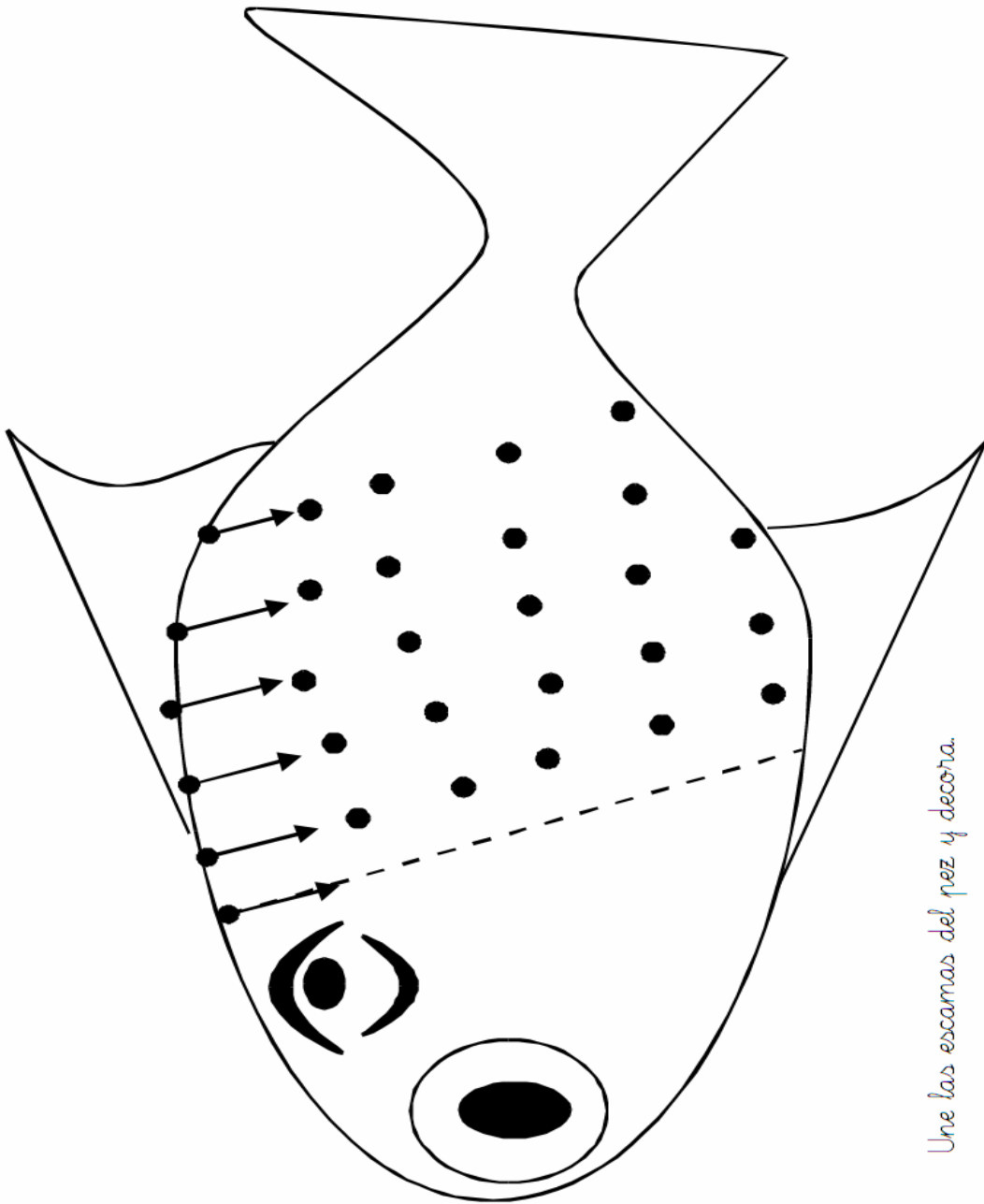

Une las escamas del pez y decórala.

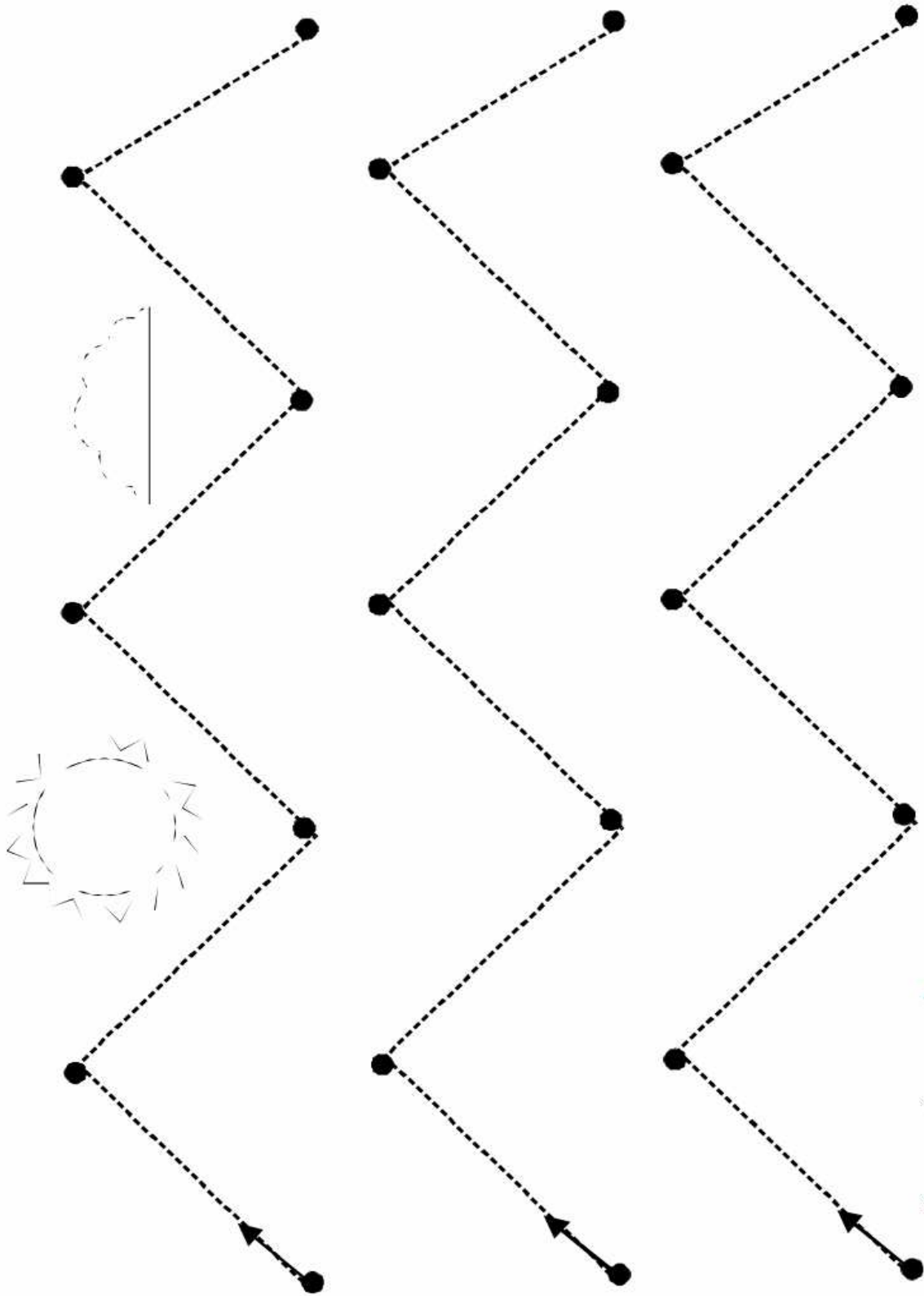

Repasa las montañas.

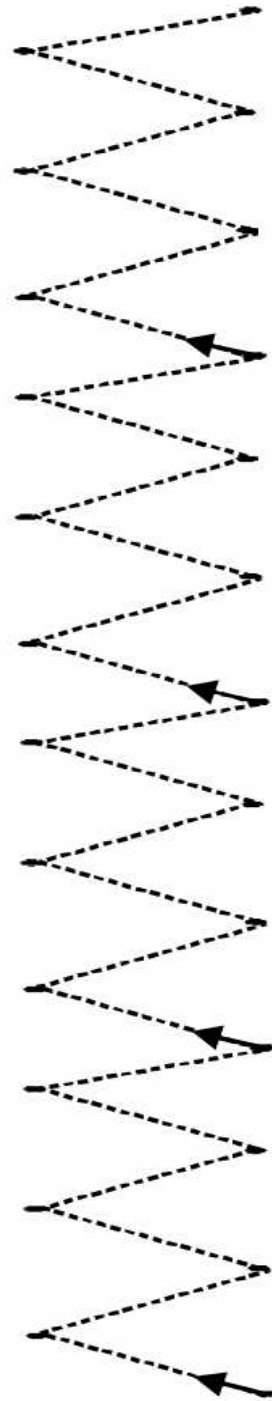
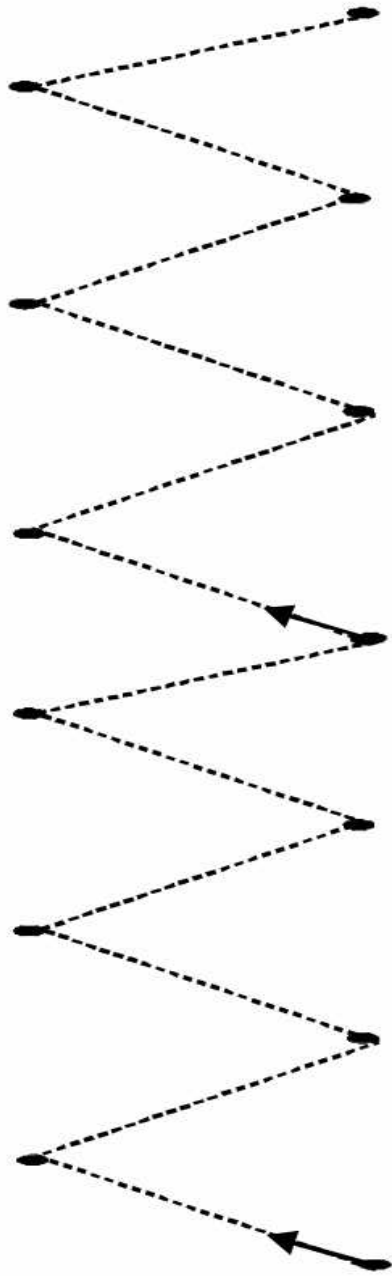
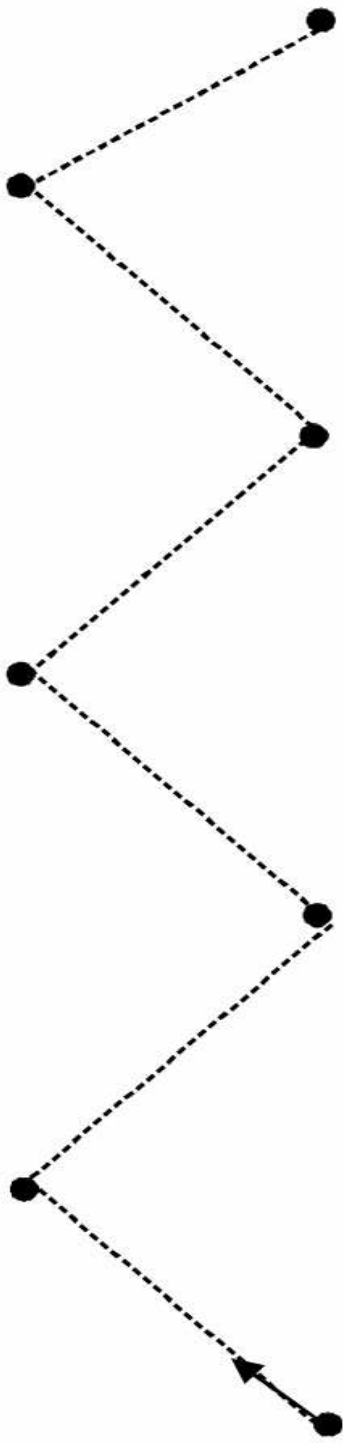

Repasa las líneas.

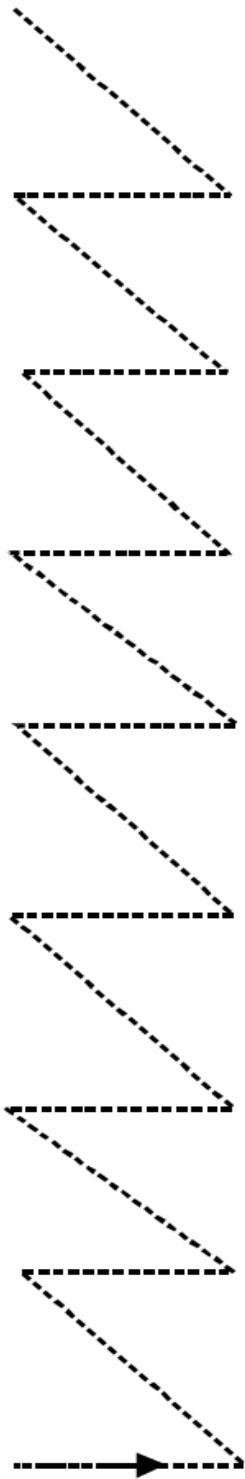
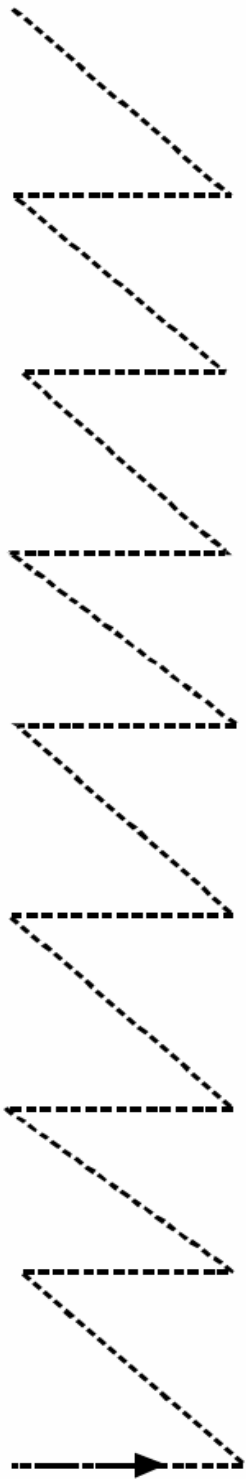
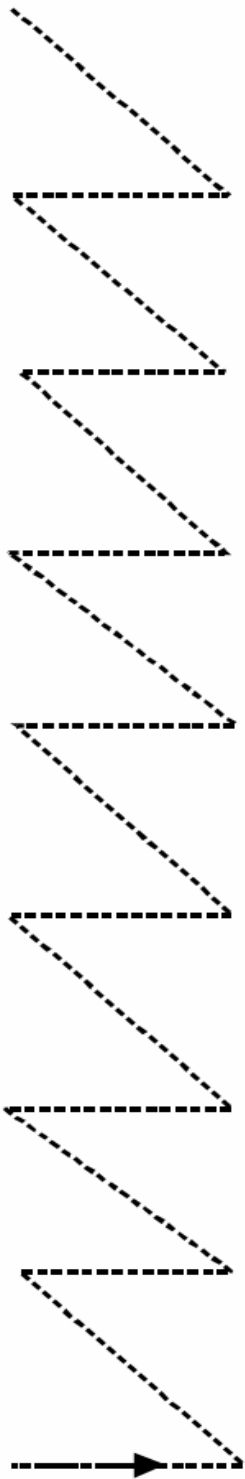

Sigue la dirección de la flecha.

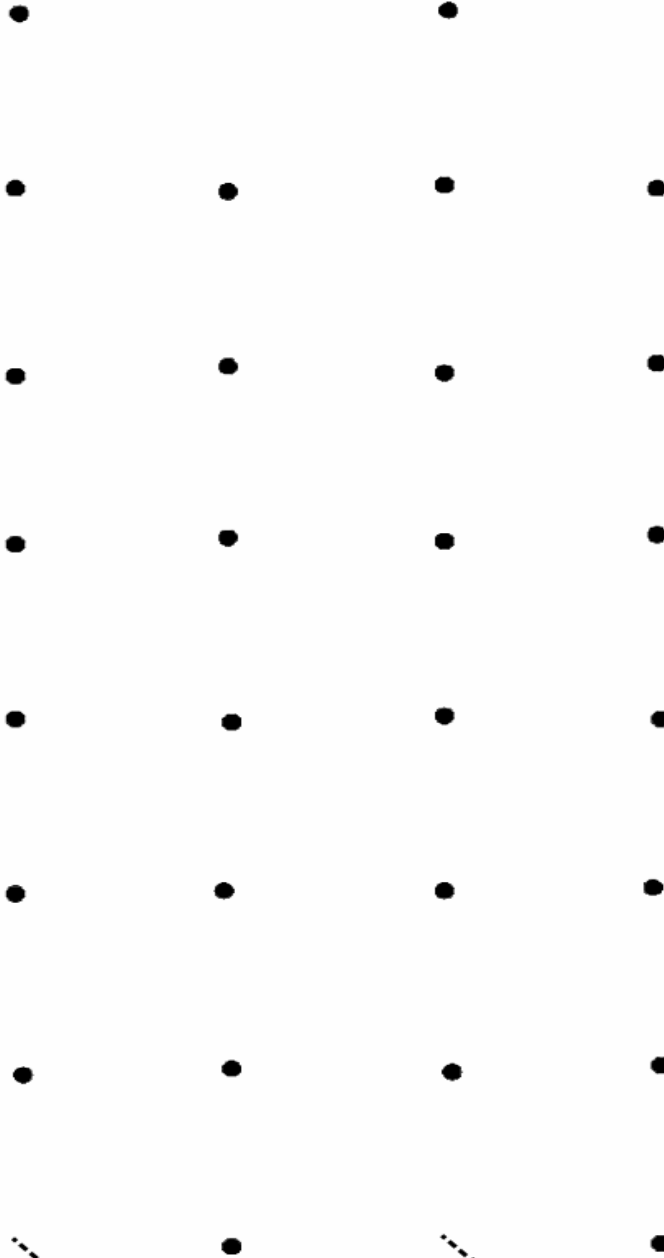
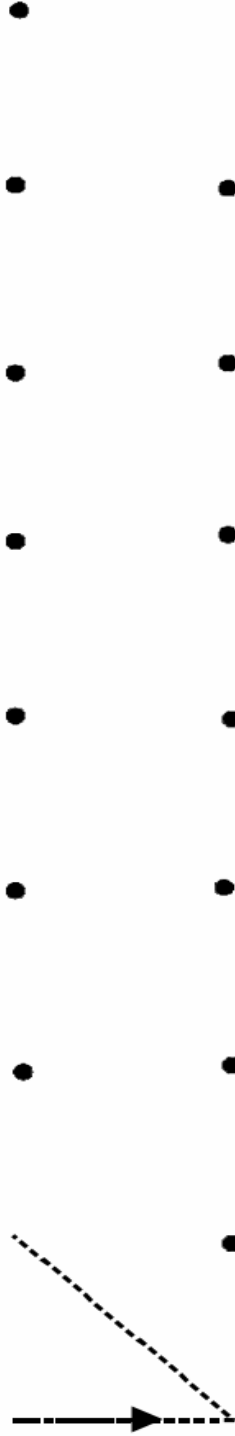
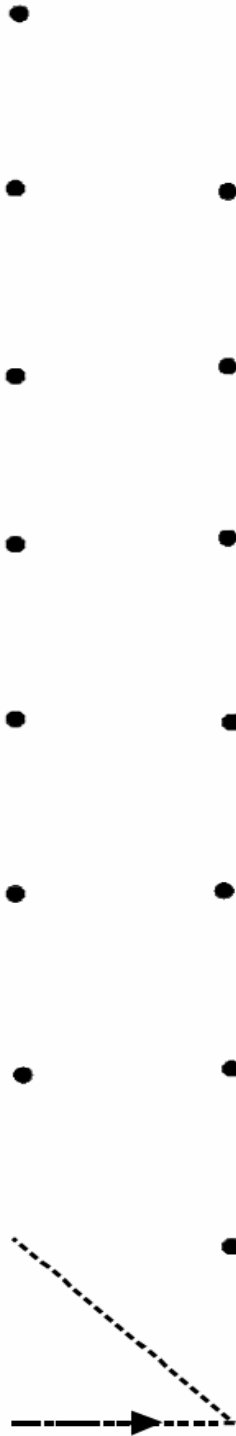
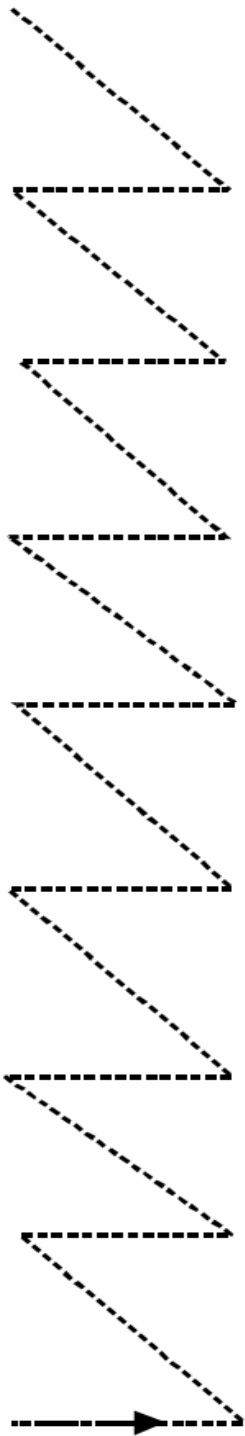

Sigue la dirección de la flecha y une los puntos.

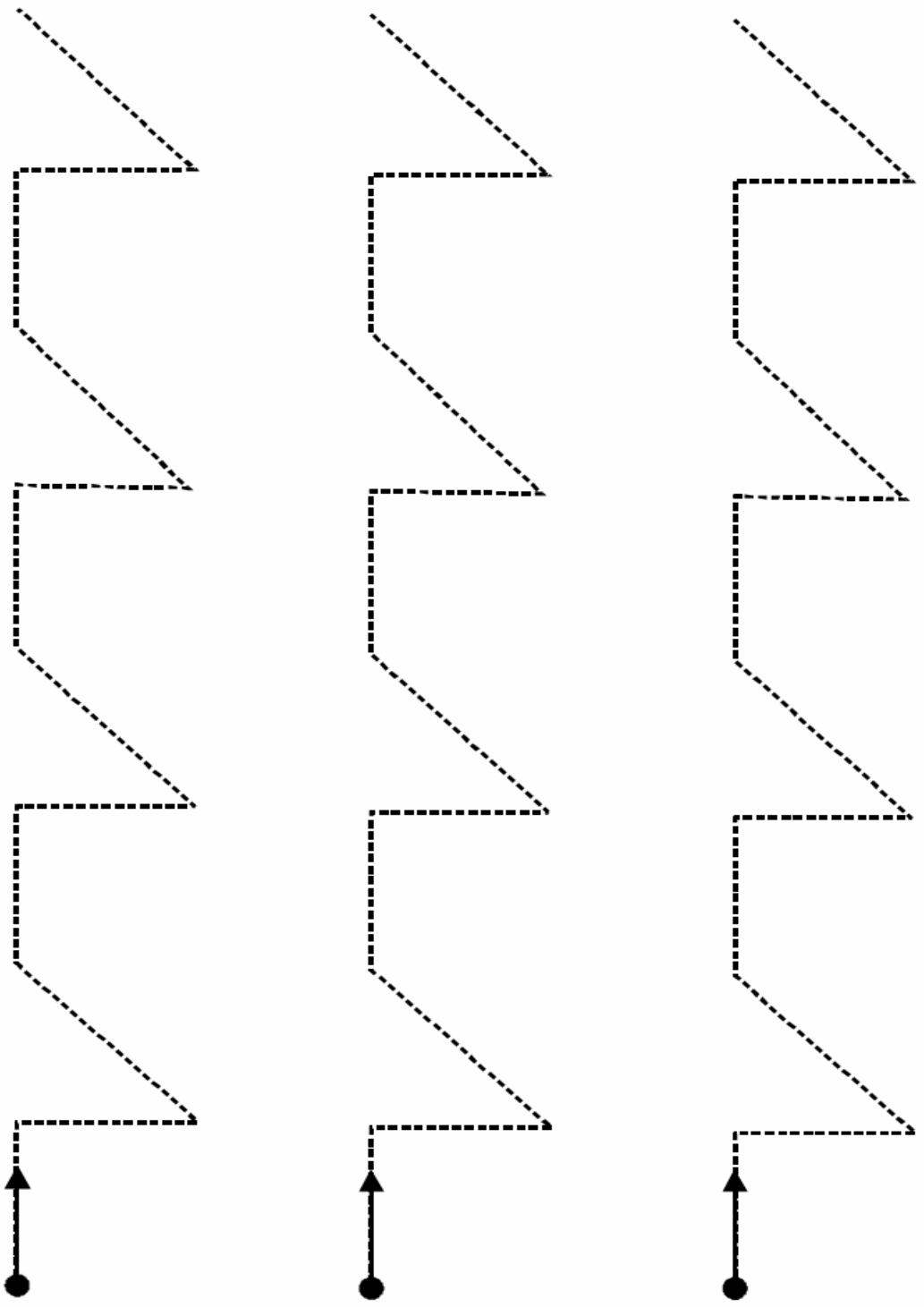

Sigue el camino.

Repasa y colorea.

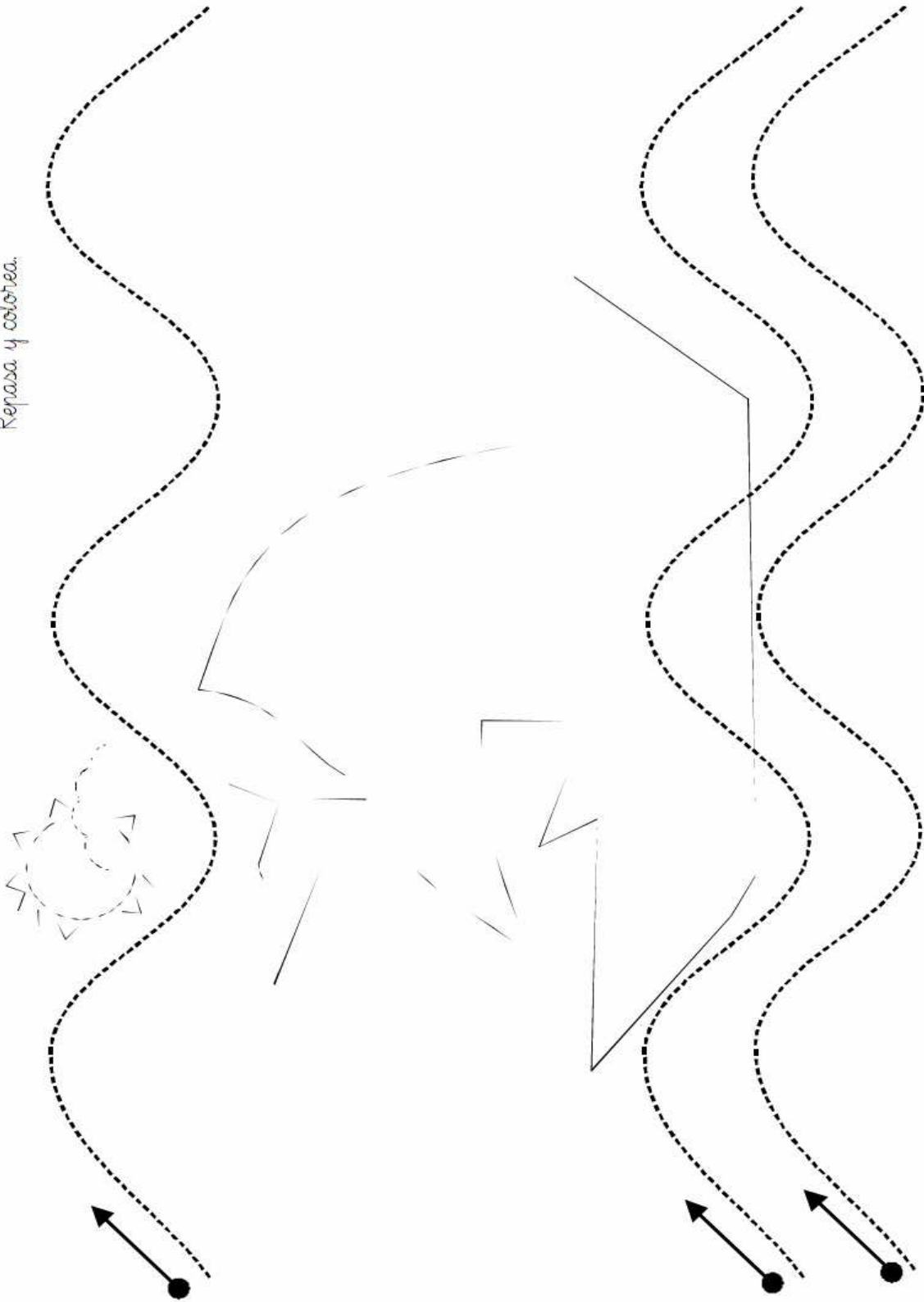

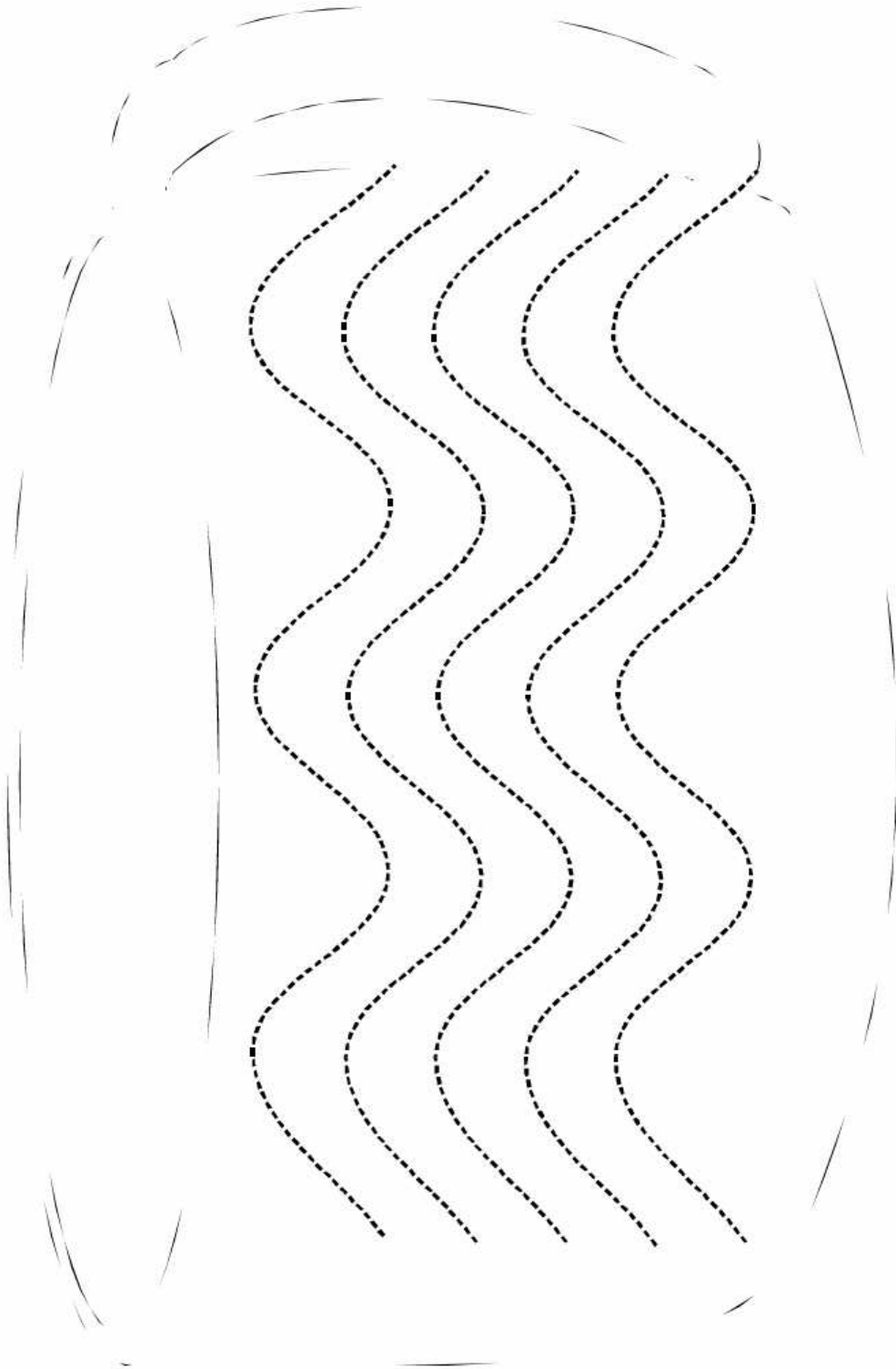

Repasa y decora.

Sigue el código y repasa.

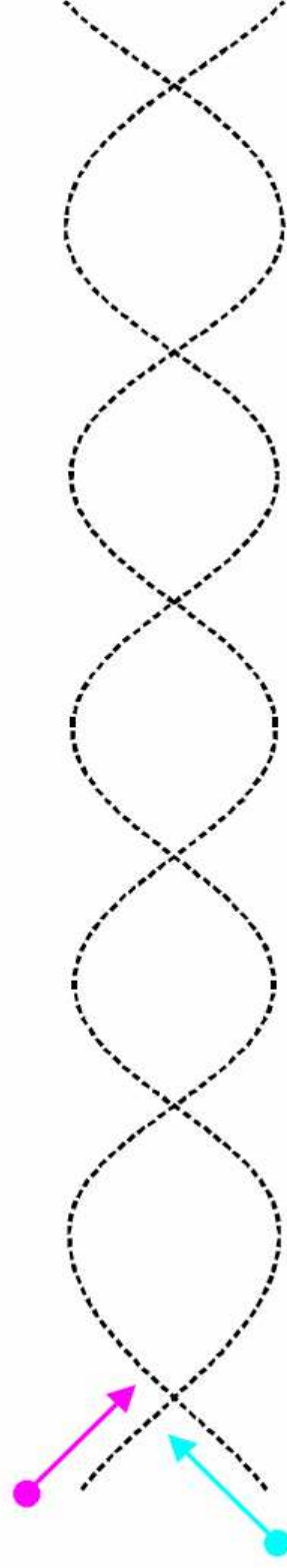
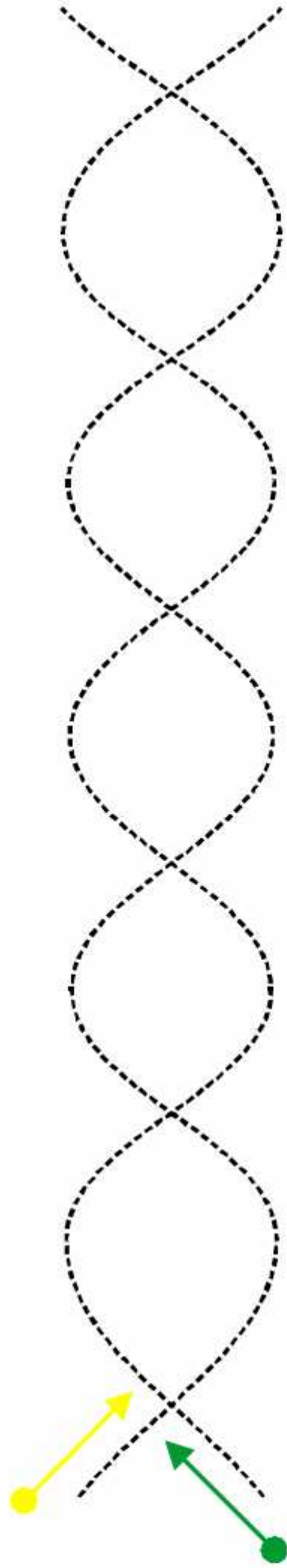
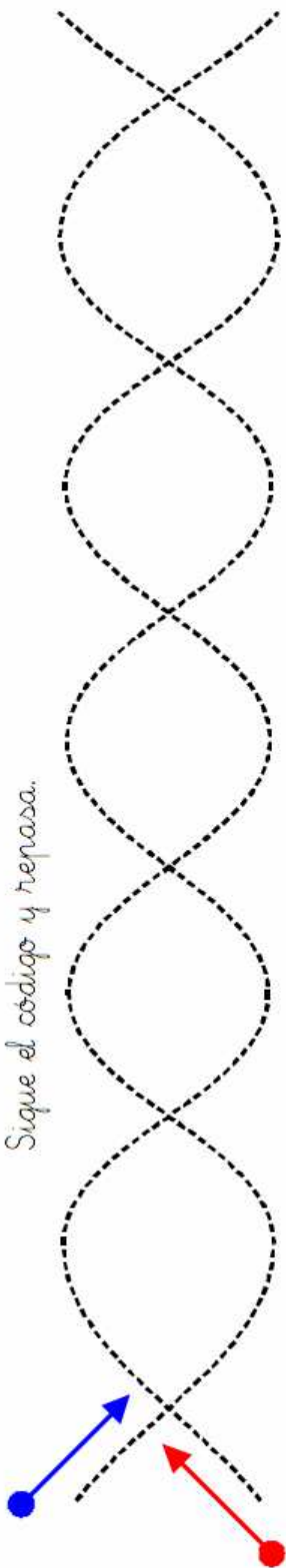

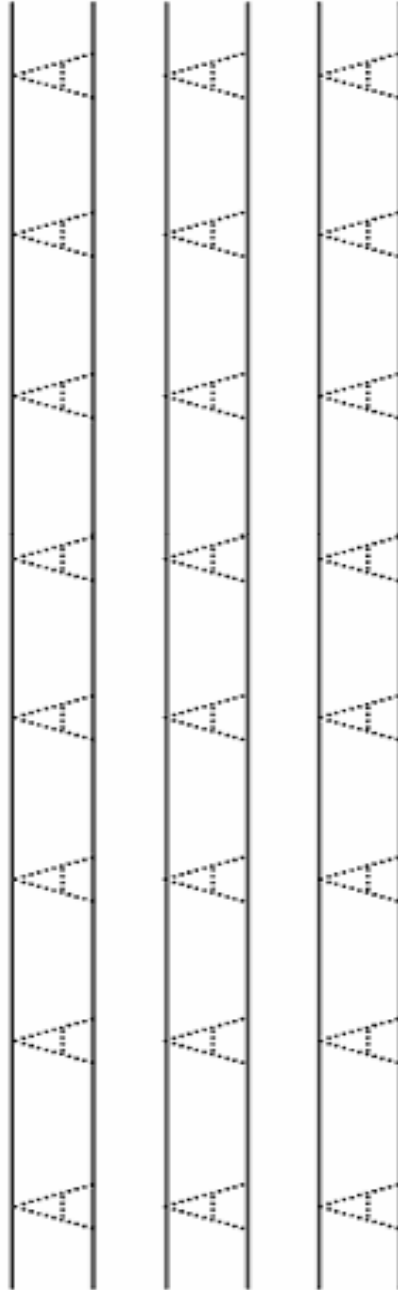
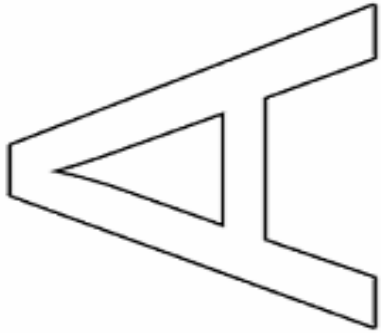
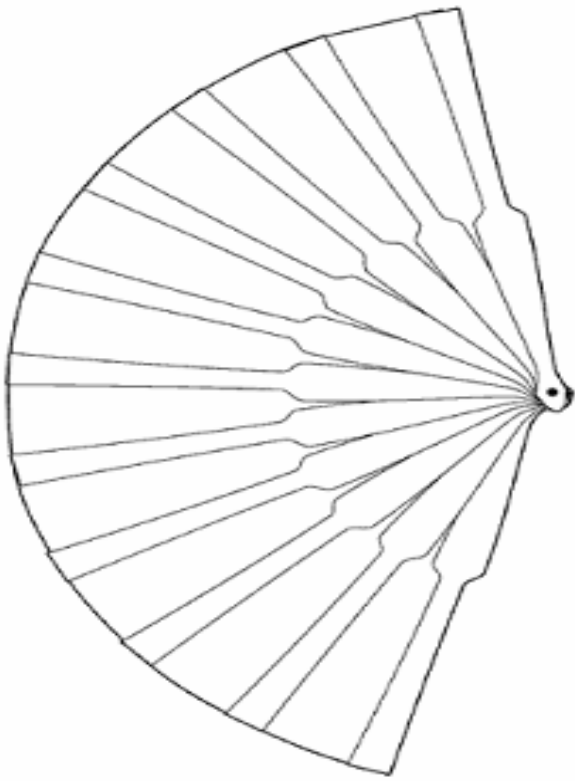

Nombre :

Curso :

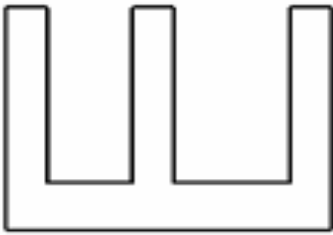

E	E	E	E	E	E	E	E	E	E
E	E	E	E	E	E	E	E	E	E
E	E	E	E	E	E	E	E	E	E
E	E	E	E	E	E	E	E	E	E

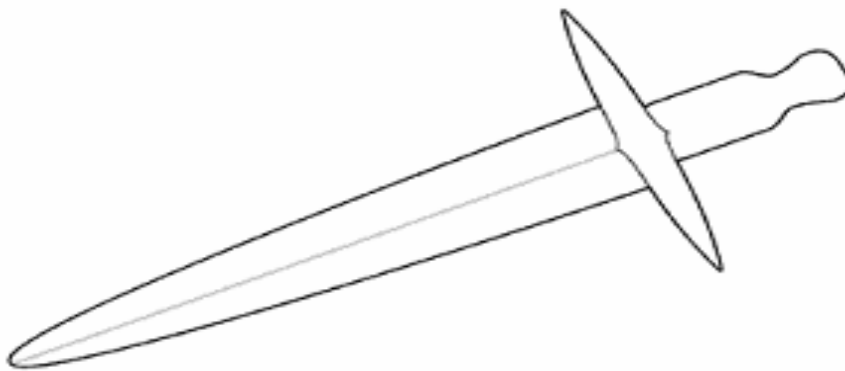

Nombre :

Curso :

ELEFANTE



ESCALERA



EDIFICIO

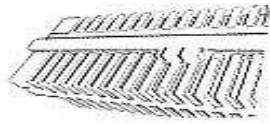

ESTRELLA

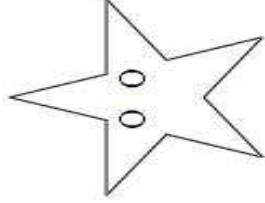

EME

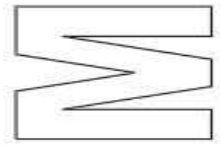

ESCOBA



Nombre: _____
 Fecha: _____

E E E E E E E E E E

E E E E E E E E E E

E E E E E E E E E E

E E E E E E E E E E

E E E E E E E E E E

www.alba-ese.com

Nombre: _____

Fecha: _____

INDIO

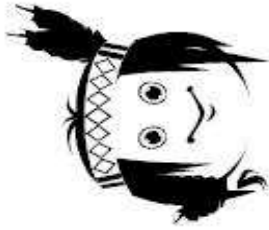

I
N
D
I
O
I
N
D
I
O
I
N
D
I
O
I
N
D
I
O
I
N
D
I
O
I
N
D
I
O
I
N
D
I
O
I
N
D
I
O

IGLÚ



ISLA



IGLESIA



INÉS



ICEBERG



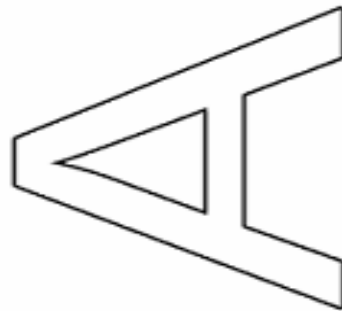
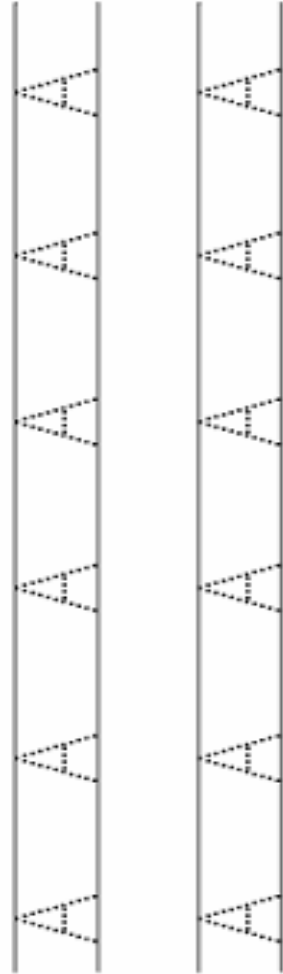
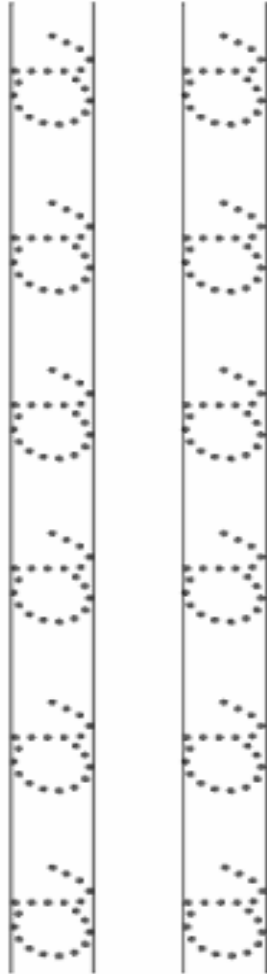
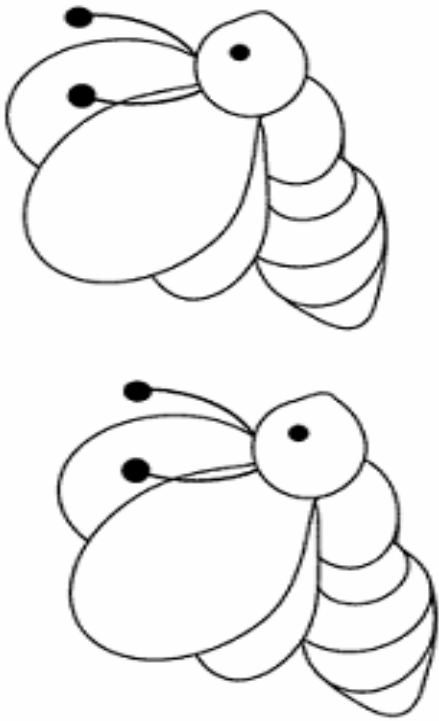

Curso :

Nombre :

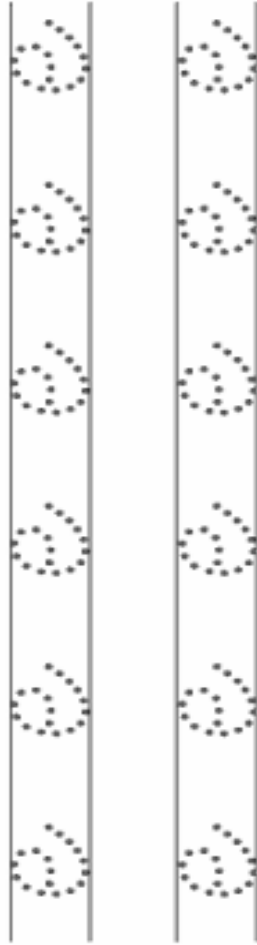
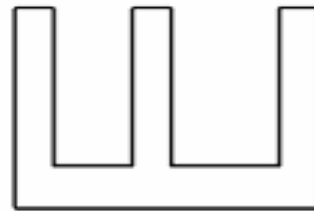
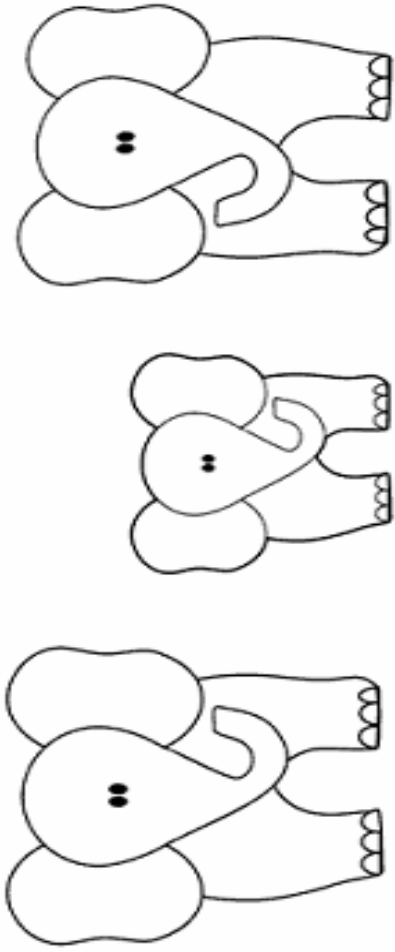

Nombre :

Curso :

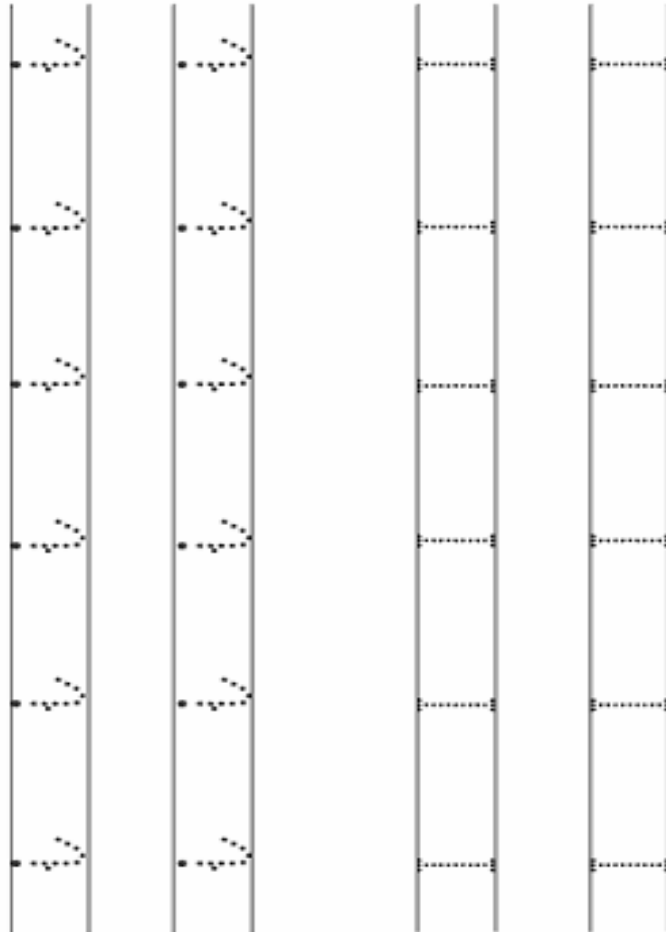
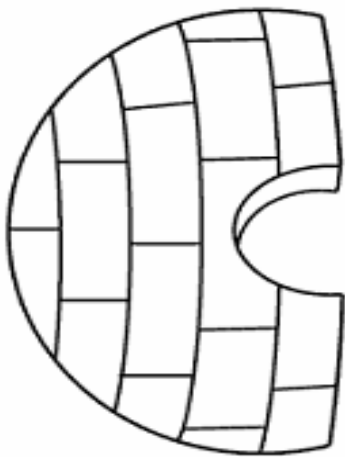

Curso :

Nombre :

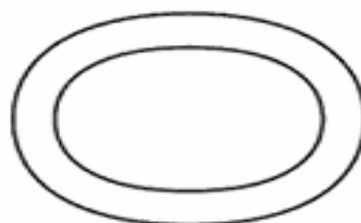
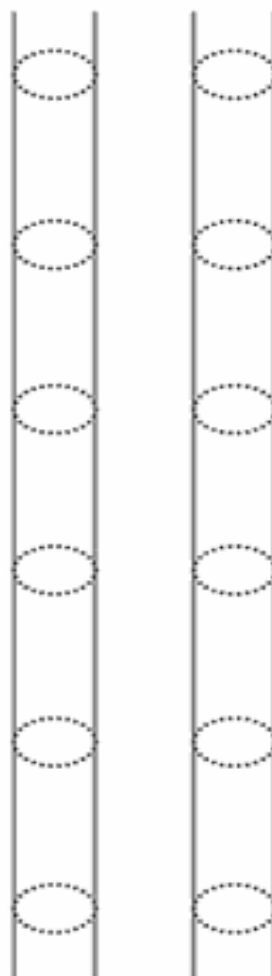
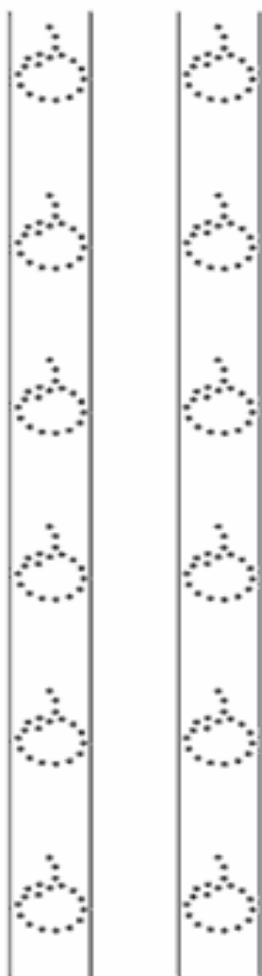

Curso :

Nombre :

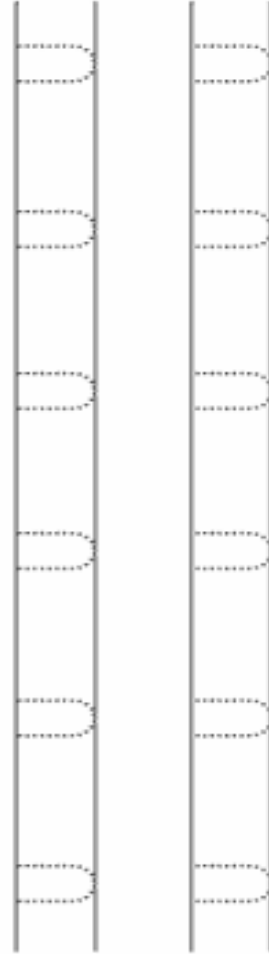
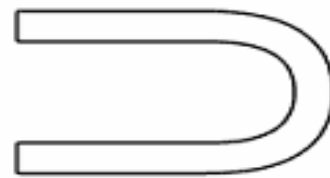

Nombre :

Curso :

.....

PUZZLES
DE
ANIMALES

PUZZLES DE LOS ANIMALES.

1. Imprimir, recortar y plastificar los animales. Pegar en el centro un trocito de velero o blu Tack
2. Imprimir en folios de colores y plastificar las láminas de las sombras.
3. Pegar en el centro de cada sombra un trocito de velero para que se unan con los animales.

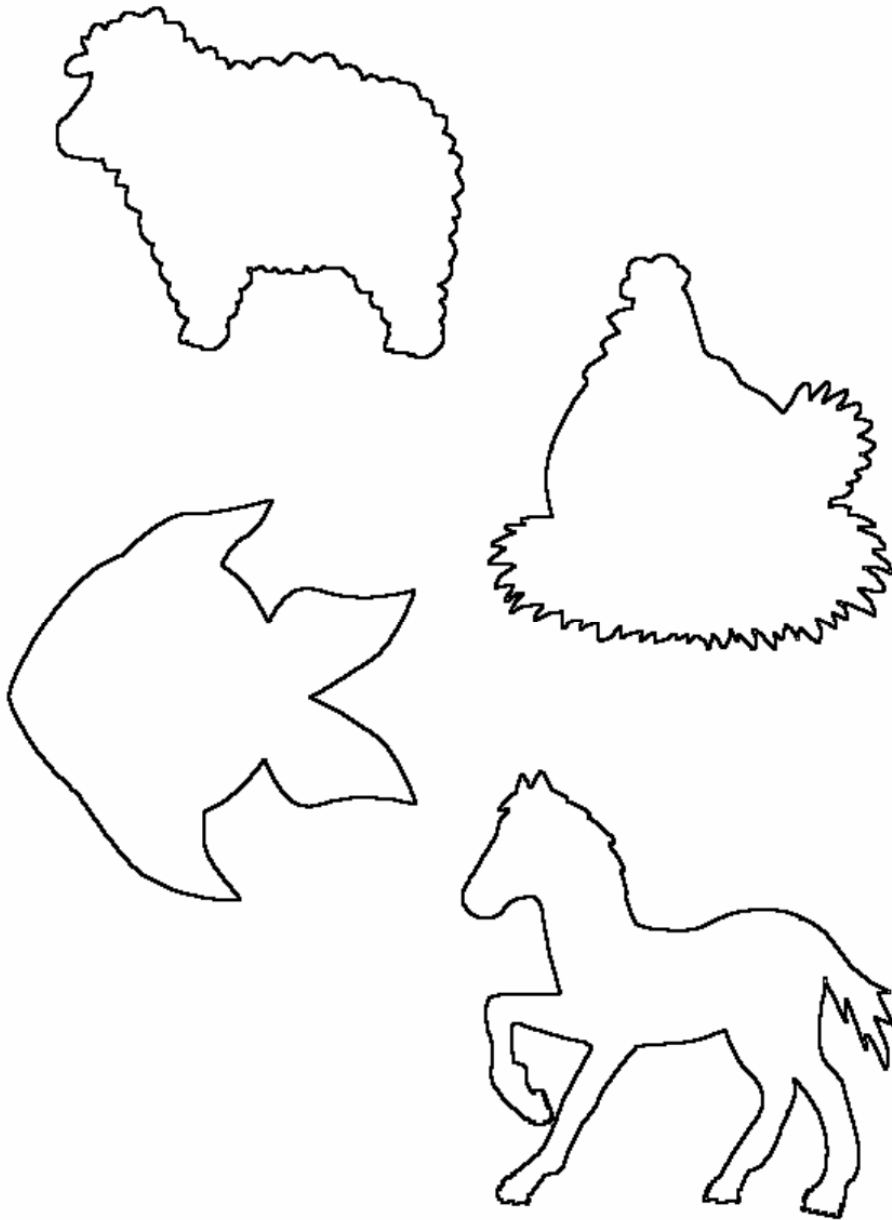

Obj. Realizar puzzles sencillos

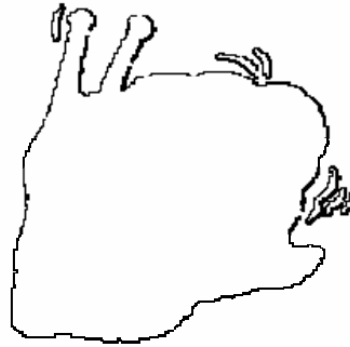
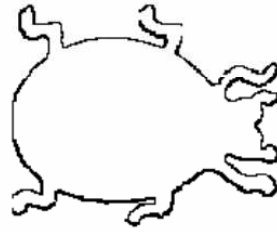
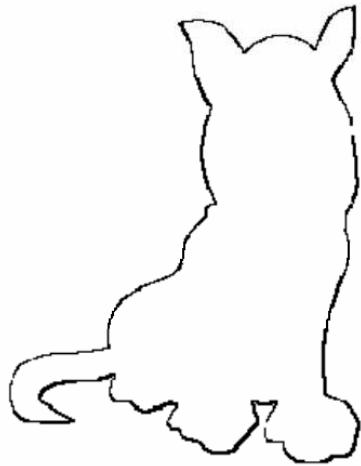
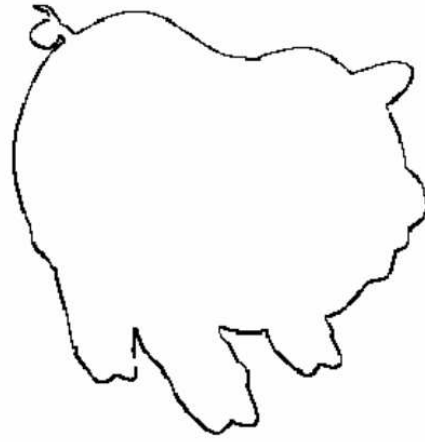
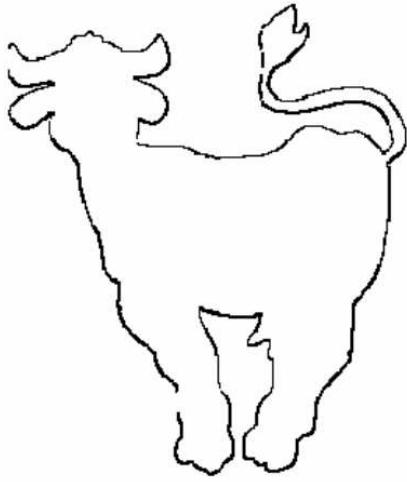

Obj. Realizar puzzles sencillos





Obj. Realizar puzzles sencillos

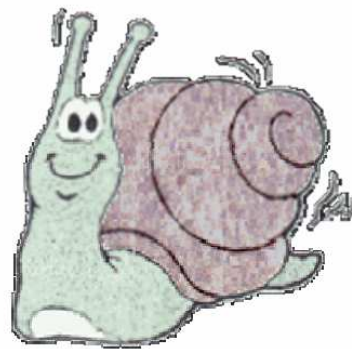
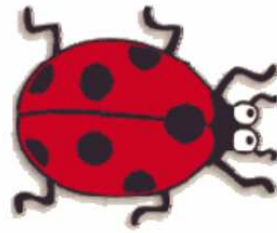
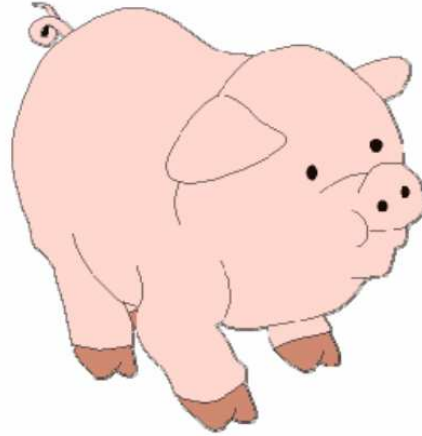
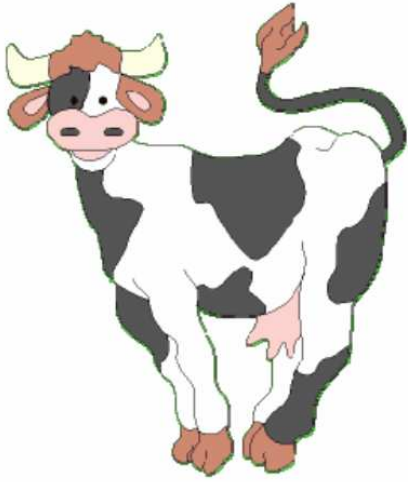

Obj. Realizar puzzles sencillos

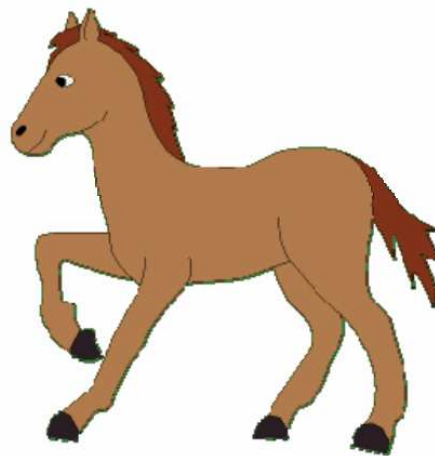
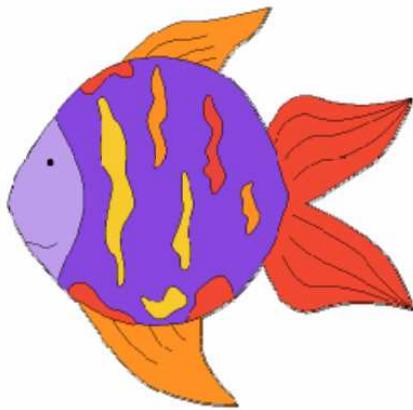
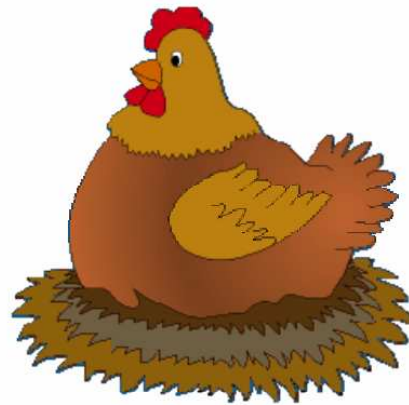
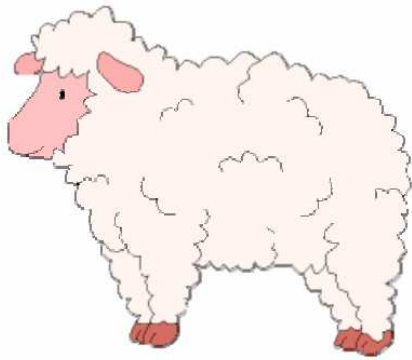

CONCEPTOS

¿Qué tenemos dentro de casa?

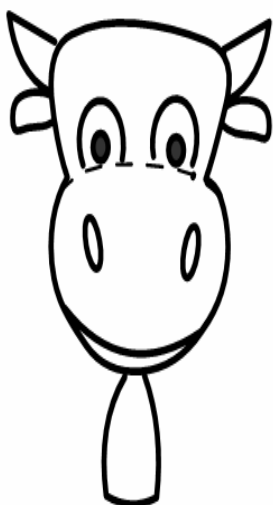
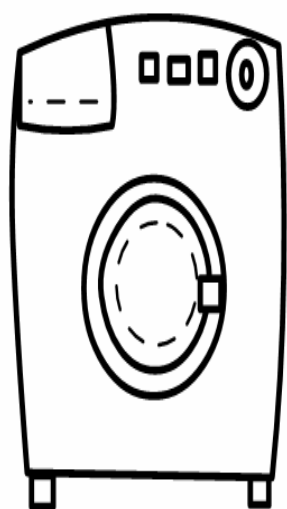

¿Qué encontramos fuera de casa?

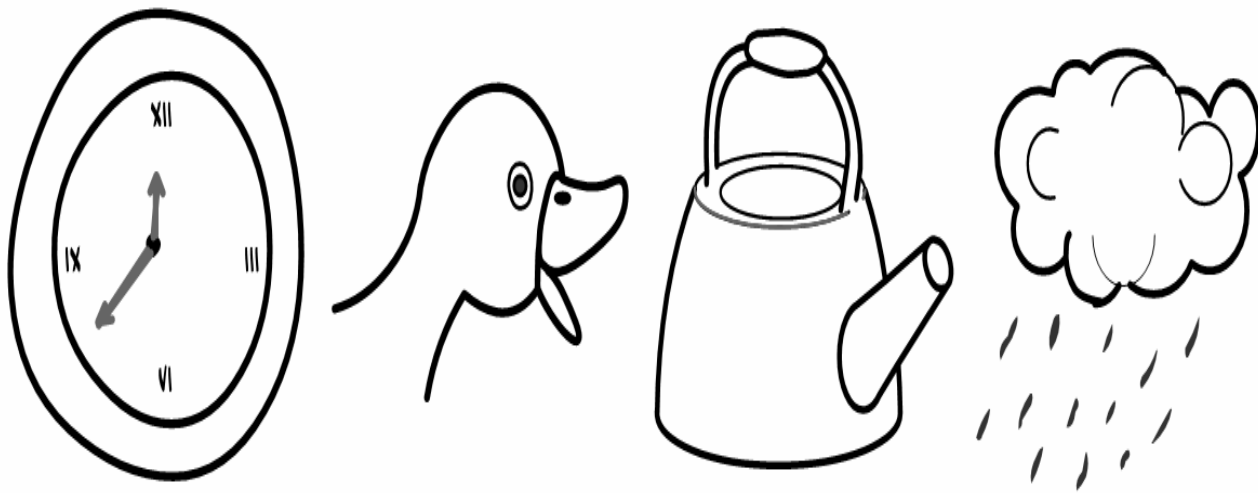

COLOREA EL MÁS LENTO

RÁPIDO - LENTO

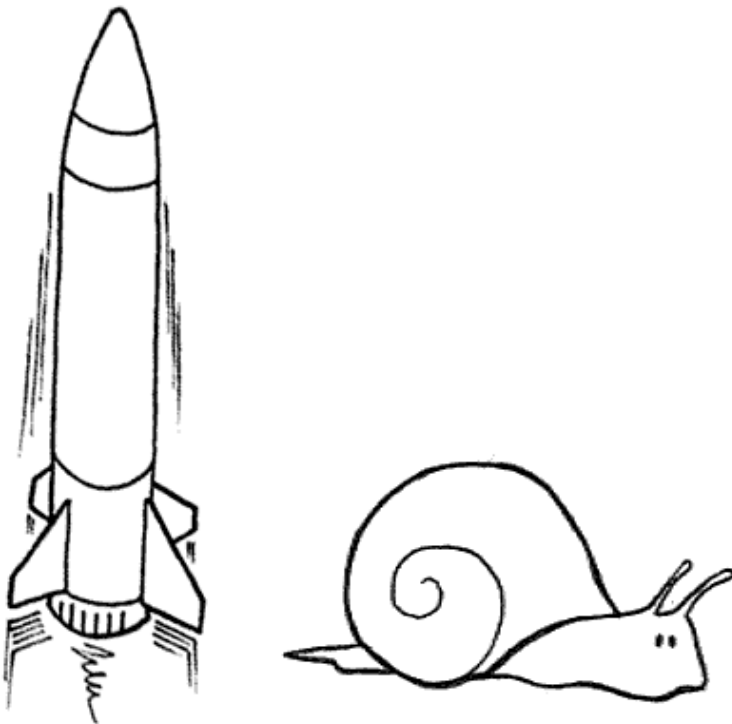

RODEA EL VASO VACÍO

LLENO - VACÍO

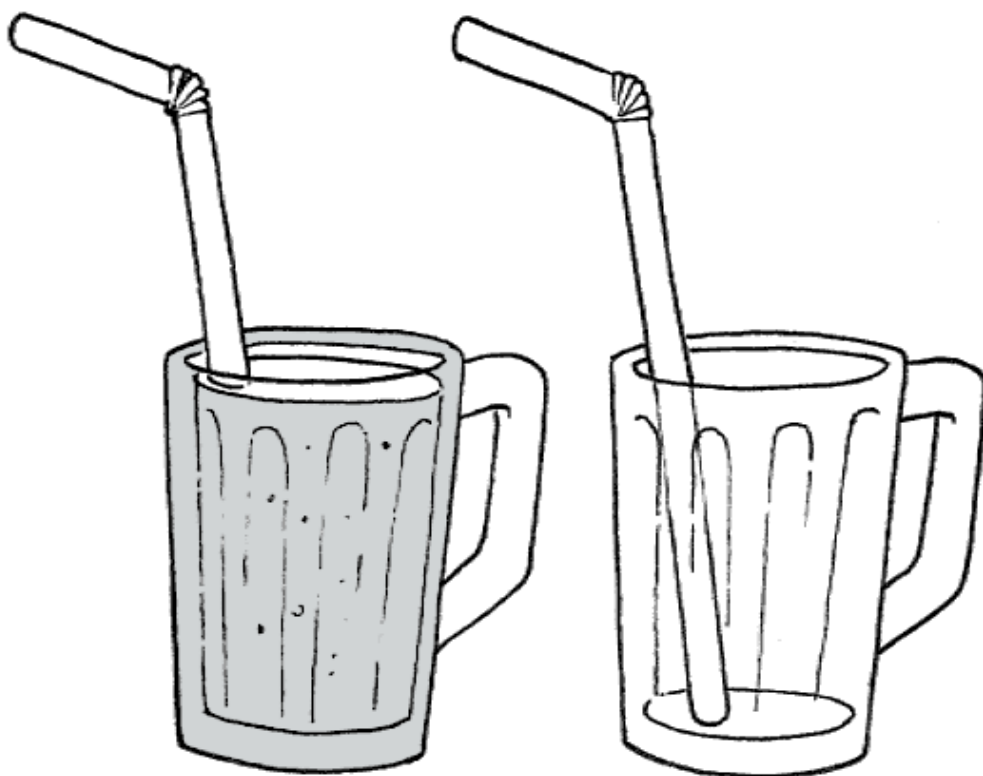

LLENO / VACÍO : Colorea la botella que está llena

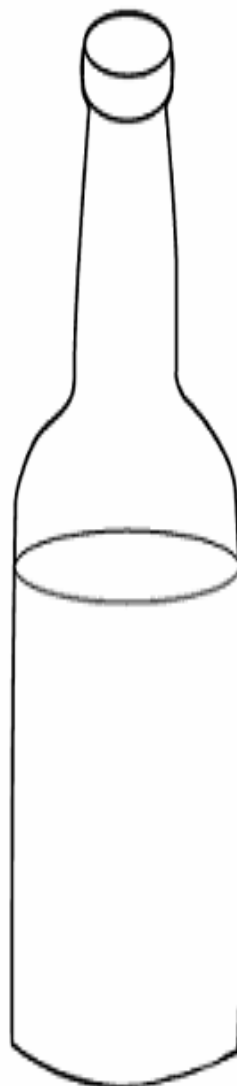
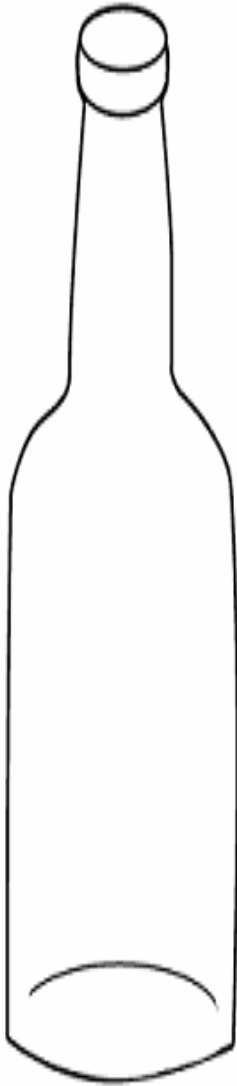

Colorea la Manzana GRANDE

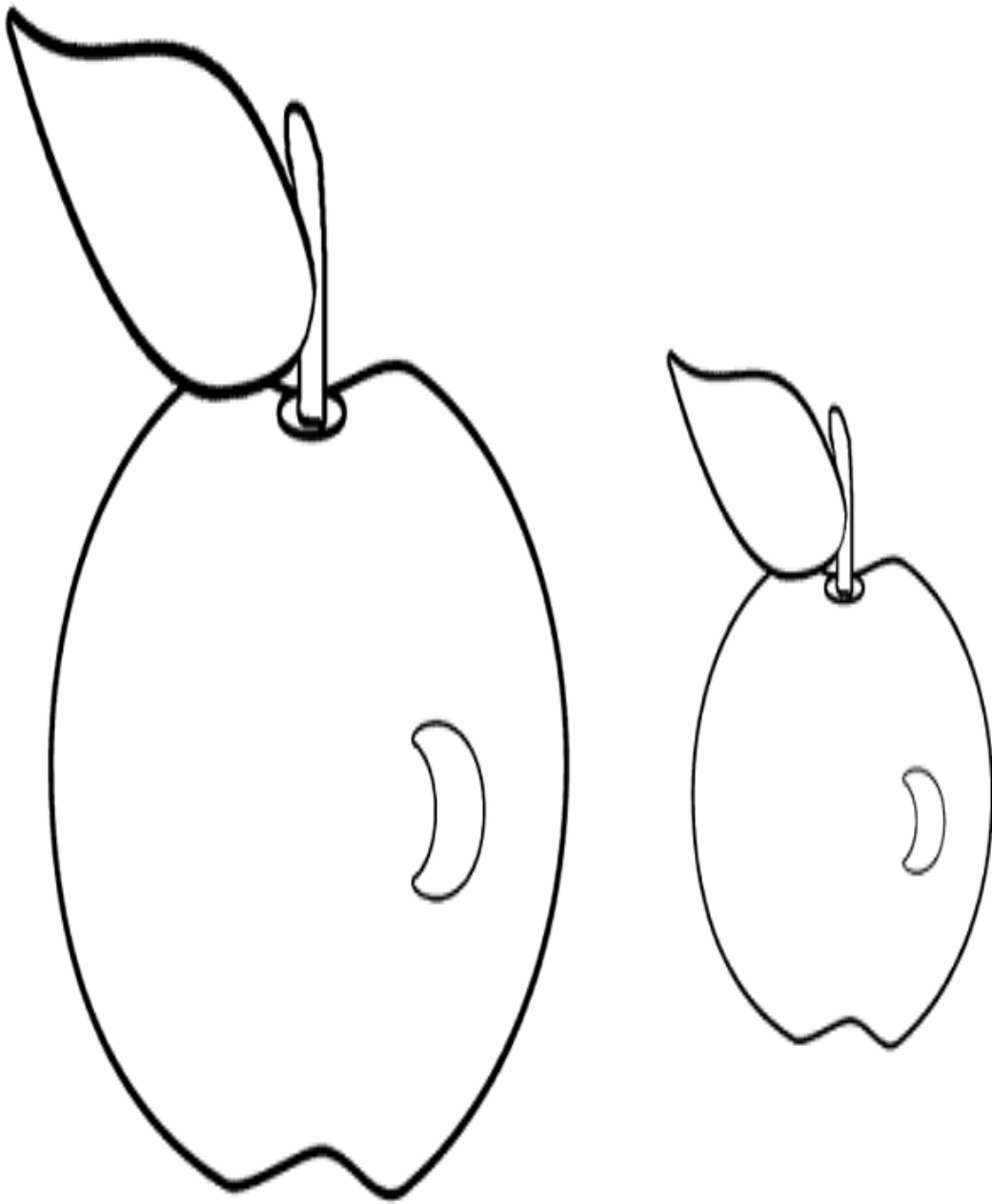

LLENO / VACÍO : Colorea la Pecera que está LLENA

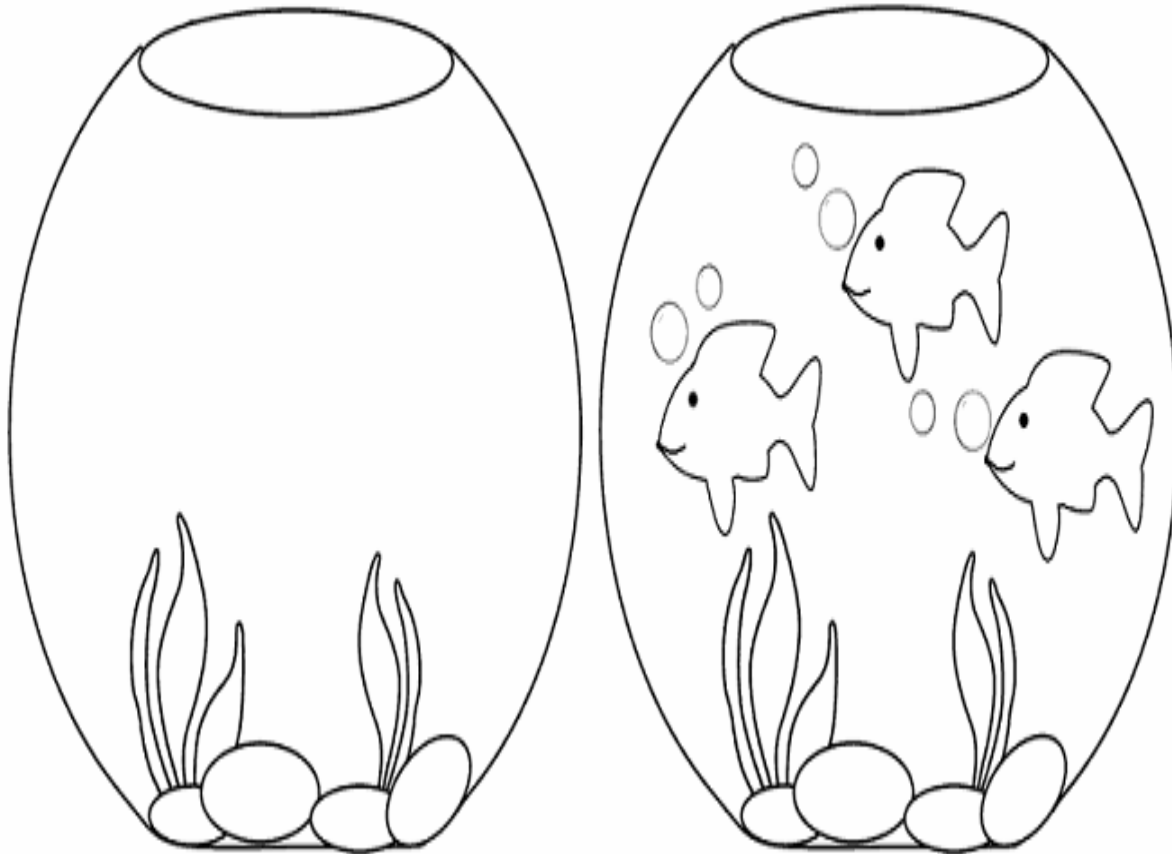

ENCIMA / DEBAJO : Colorea las gallinas que hay debajo

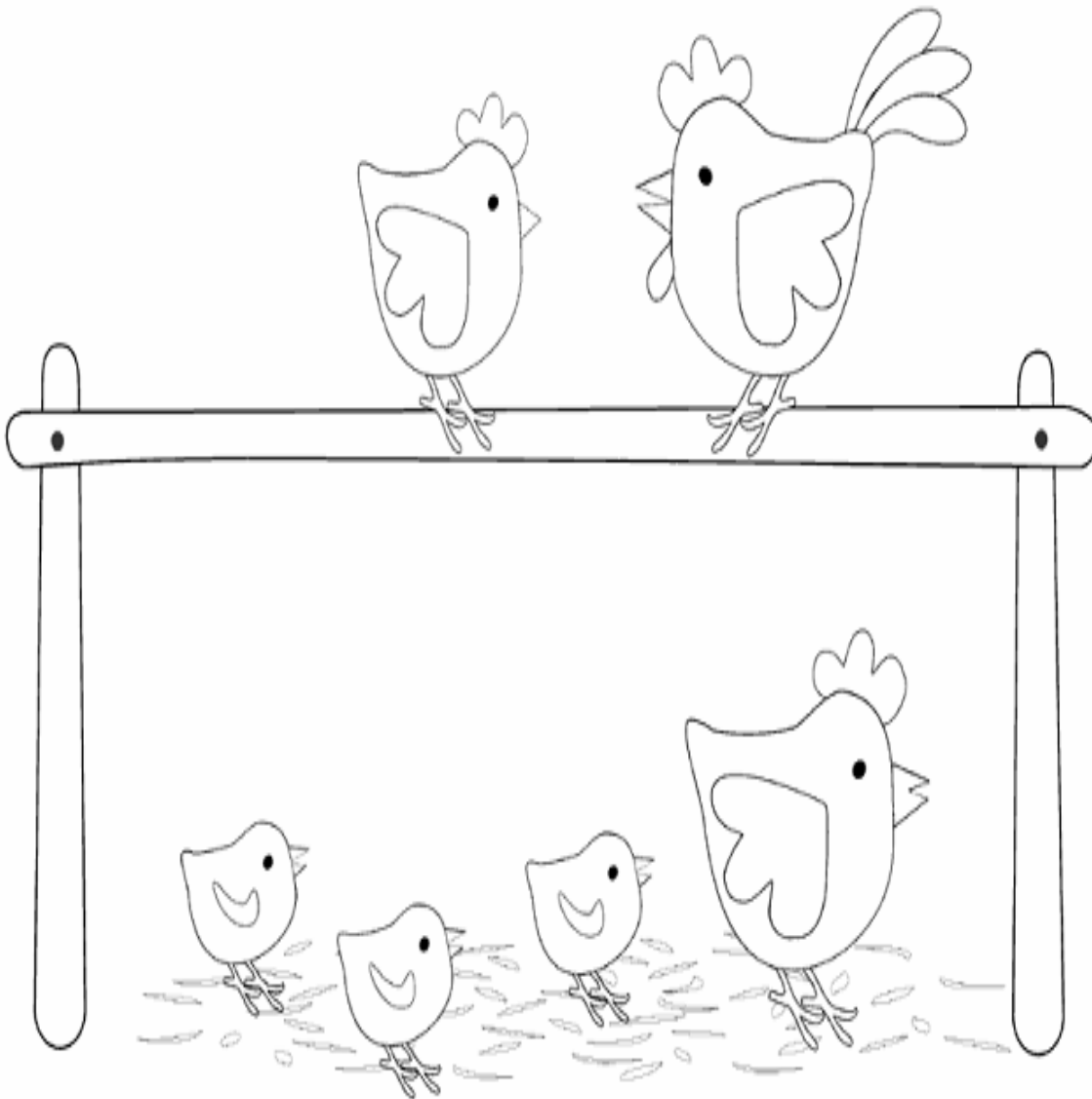

GRANDE / MEDIANO / PEQUEÑO : Colorea el gallo Grande y rodea con un círculo el mediano

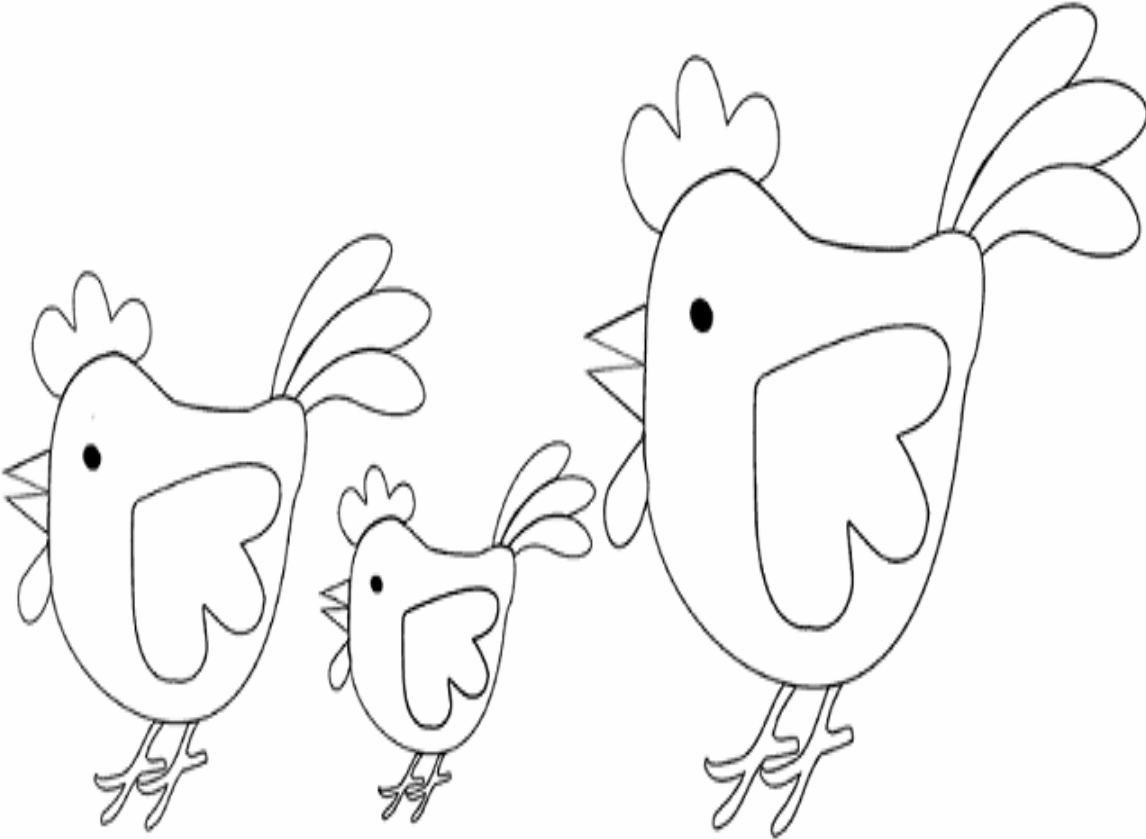



SEGUIMOS LA SERIE

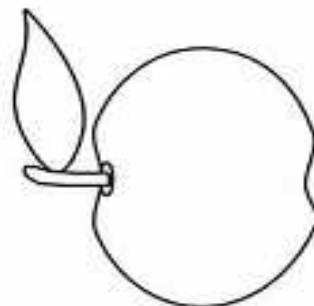
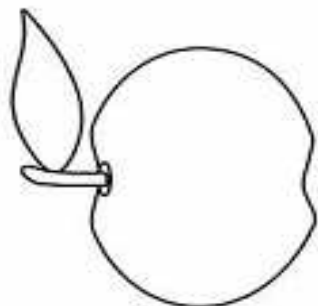
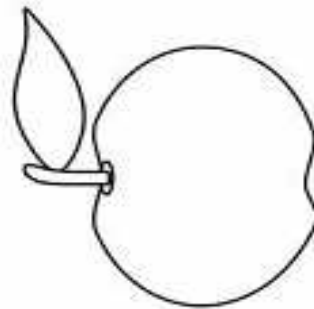
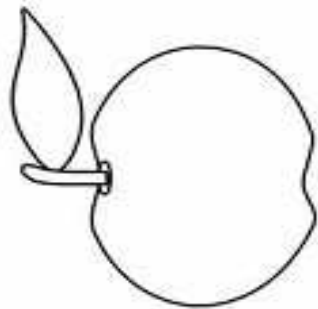
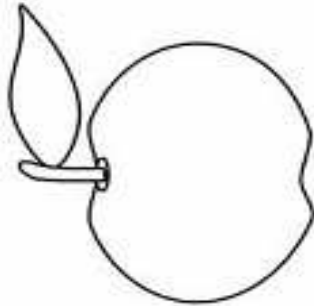
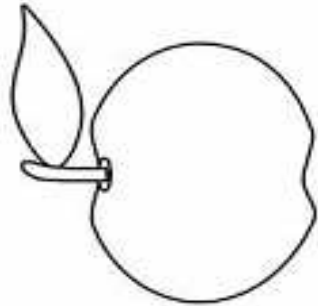
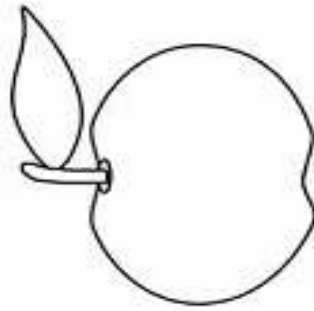
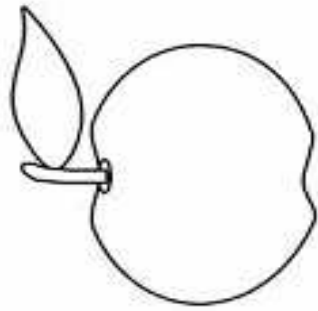

SERIE :



SERIE:   

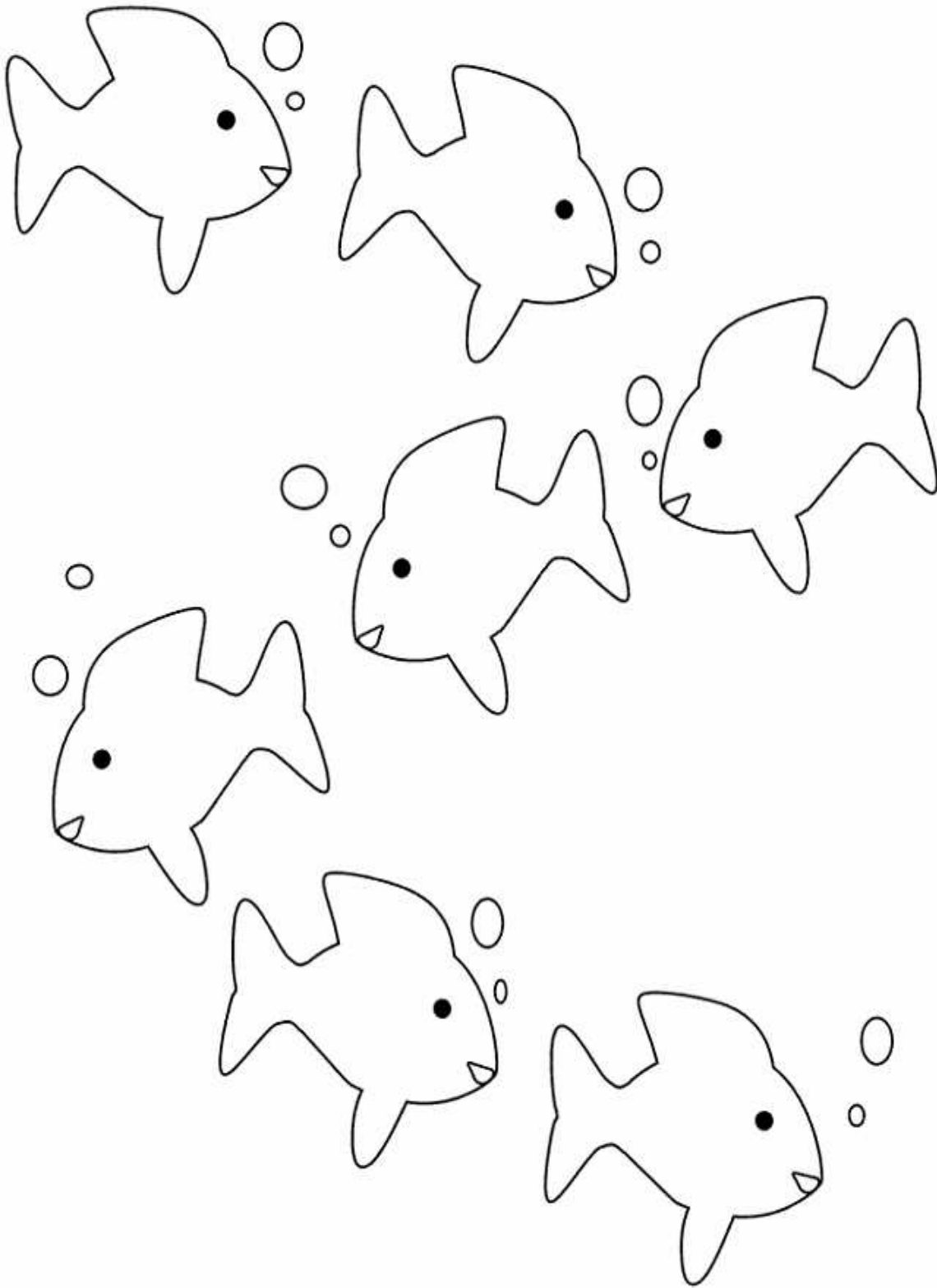

Rojo / Verde

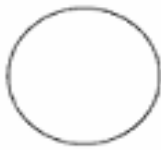
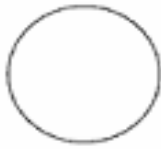
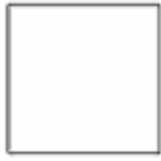

Azul / Amarillo

